



KLM1601

Intelligent Fresh Ground Coffee Machine
Service Manual

KLM1601-SM-EN V003



English

Contents

1. Introduction	4
General warnings	4
Symbol description	5
2. Structure	6
2.1 Overview	6
2.2 Description of internal components	8
2.3 Water circuit	9
2.3.1 Overview of water circuit	9
2.3.2 Water circuit for making coffee	10
2.3.3 Water circuit for making steam	11
2.3.4 Water circuit for making hot water	12
2.4 Schematic circuit diagram	13
2.5 Technical data	14
3. Troubleshooting	15
3.1 Troubleshooting check list	15
3.2 Check list for minor failure	32
4. Repair	37
4.1 Tools preparation	37
4.2 General disassembly	38
4.2.1 Disassemble exterior parts	38
4.2.2 Disassemble power cord	41
4.2.3 Disassemble brew unit	42
4.2.4 Disassemble valve support group	43
4.2.5 Disassemble flowmeter	43
4.2.6 Disassemble solenoid valve group	44
4.2.7 Disassemble grinder group	44
4.2.8 Disassemble control panel group	45
4.2.9 Disassemble dispenser valve group	46
4.2.10 Disassemble drainage valve group	47
4.2.11 Disassemble pump group	48
4.2.12 Disassemble PCBA	49
4.2.13 Disassemble dispenser valve 2W	49
4.2.14 Disassemble dispenser valve 3W group	50

4.2.15 Disassemble thermoblock group	50
4.2.16 Disassemble ground coffee container lid switch group	51
4.3 Precautions for maintenance and installation	53
4.3.1 Brew unit group	53
4.3.2 Dispenser valve 6W	56
4.3.3 Grinder group	58
4.3.4 Control panel group	61
Precautions for assembling	65
5. Function test and maintenance	76
5.1 Function test and test standards	76
5.2 Coffee machine maintenance	76
5.2.1 Coffee machine decalcifying	76
5.2.2 Rinse the brew unit	78
5.2.3 Rinse the foam milk unit	78
5.2.4 Wipe the coffee machine	79
6. Explosive view	82

1. Introduction

The manufacturer reserves the right to make product improvements. We guarantee that this manual respects the technological status at the time the machine is supplied.

We are open to any suggestions from technicians which may improve the product and the manual.

General warnings

- Once the packaging has been removed make sure the appliance is in good condition; if you have any doubts, check the fault and contact the retailer or manufacturer directly.
- Packaging must not be left where children can reach it as it is a potential hazard source.
- The appliance must be installed in compliance with the safety standards in force in the country of use.
- This appliance is completely safe only when it is connected to an effective earthing system that complies with the safety standards. Make sure that the mains power is sufficient for the energy required for the machine.
- It is inadvisable to use extension leads or electrical adaptors for multiple sockets. If it is essential to use them, use only single adaptors or leads that comply with the current safety standards. Never exceed the capacity indicated on the adaptor or leads, or the maximum power indicated on the adaptor.
- This appliance should only be used for what it has been designed. Any other use is considered improper and consequently dangerous. The manufacturer cannot be held responsible for any damages caused due to an erroneous or irrational use. The technician must remind the user about the safety standards to ensure correct operation of the appliance.
- The use of an electrical appliance is subject to the safety standards.
- If the customer decides not going to use the appliance for a long time, the power cable must be disconnected from the mains and empty the water container.
- To guarantee that the coffee-maker works properly and efficiently, it is essential to follow the manufacturer's instructions, and carrying out periodical maintenance and check of all the safety devices.
- Always make sure that hands, or other parts of the body, never come within the range of the coffee dispensing spouts or those of steam and hot water so as not to be scalded.
- The maintenance technician must inform the retailer or manufacturer promptly of any problems when installing or using the appliance.
- The coffee machine must be used at the temperature between 5 C and 40 C.

Symbol description

Non-compliance with the operation, may cause electric shock, and threat to life.



Non-compliance with the operation may cause coffee machine damaged, or personal injury.



Non-compliance with the operation, may cause scalded or burned.



This symbol, if prompted, please carefully read information with it.



This symbol, if prompted, represents recycle.



2. Structure

2.1 Overview



- | | |
|-----------------------------|------------------------------|
| ① Bean container lid | ⑩ Front cover right |
| ② Top cover | ⑪ Touch screen |
| ③ Water tank cover | ⑫ Rotary |
| ④ Water tank ornament cover | ⑬ Clean button |
| ⑤ Water tank | ⑭ Decorative plate |
| ⑥ Support elect | ⑮ Handle |
| ⑦ Power button | ⑯ Drip tray decoration cover |
| ⑧ Front cover left | ⑰ Drip tray cover |
| ⑨ Cup support | ⑱ Drip tray |



- 19 Bean container
- 20 Grinder adjustment knob
- 21 Ground coffee container lid

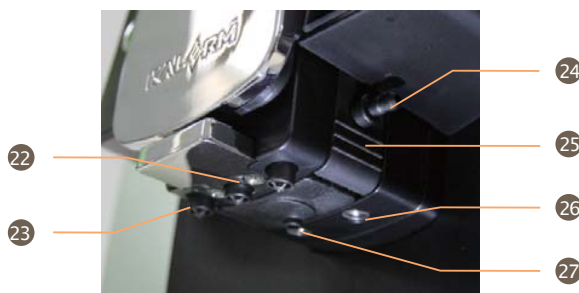

- 22 Hot water export
- 23 Coffee export
- 24 Milk connector
- 25 Foam rubber
- 26 Light for coffee
- 27 Milk and foam export



- 28 Back cover
- 29 Logo
- 30 Right side section

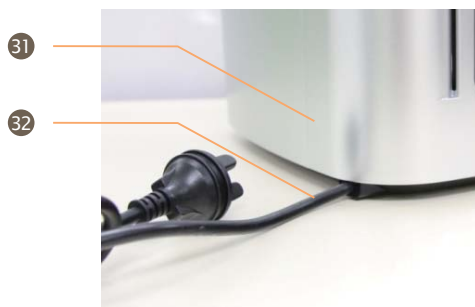

- 31 Left side section
- 32 Power line

2.2 内部组件说明

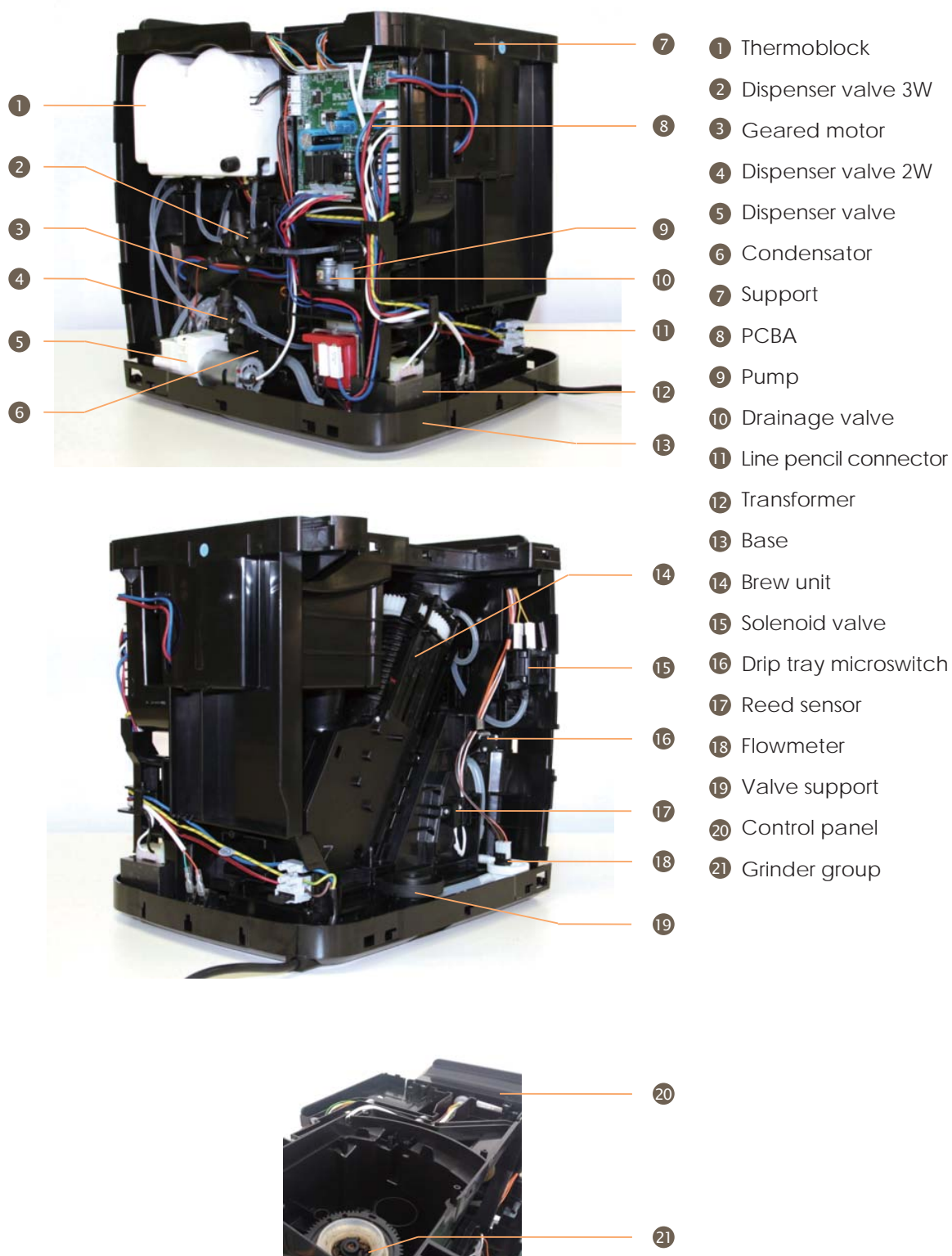

2.3 Water circuit

2.3.1 Overview of water circuit

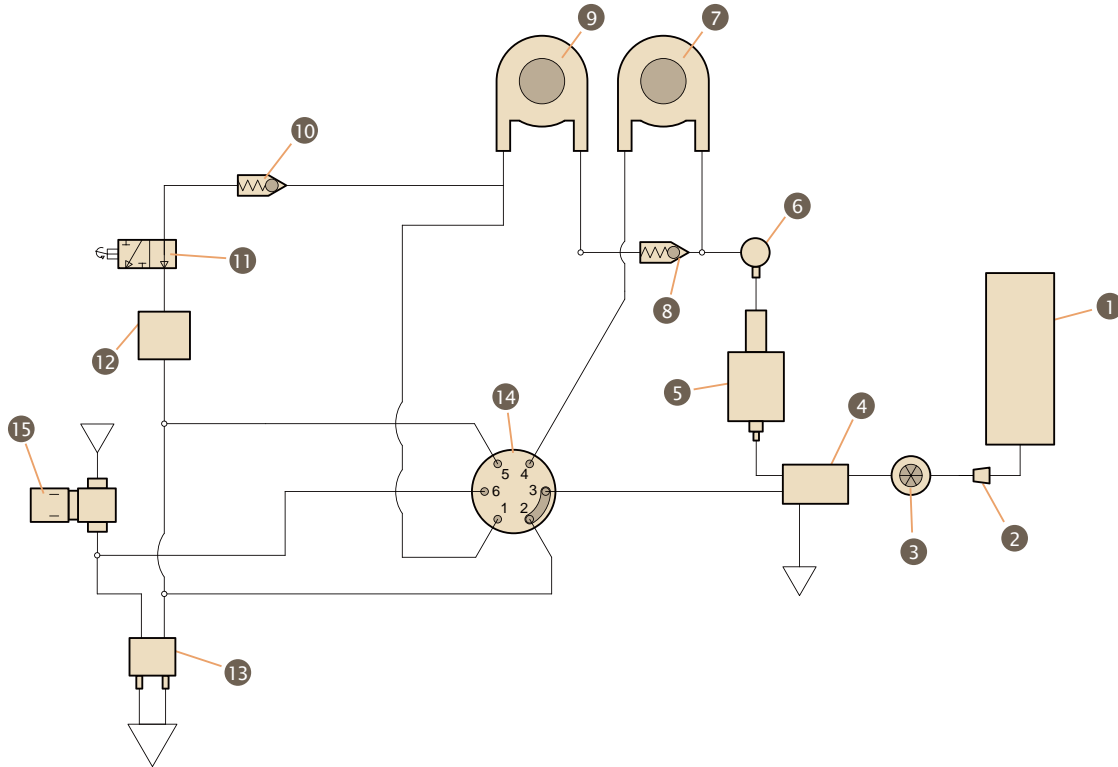

- | | | | |
|---|----------------------------|---|--------------------|
| ① | Water tank | ⑨ | Coffee thermoblock |
| ② | Sieve | ⑩ | Dispenser valve 2W |
| ③ | Flowmeter | ⑪ | Drainage valve |
| ④ | Condensator | ⑫ | Brew unit |
| ⑤ | Pump | ⑬ | Beverage export |
| ⑥ | Pressure maintaining valve | ⑭ | Reversing valve |
| ⑦ | Steam thermoblock | ⑮ | Solenoid valve |
| ⑧ | Dispenser valve 3W | | |

2.3.2 Water circuit for making coffee

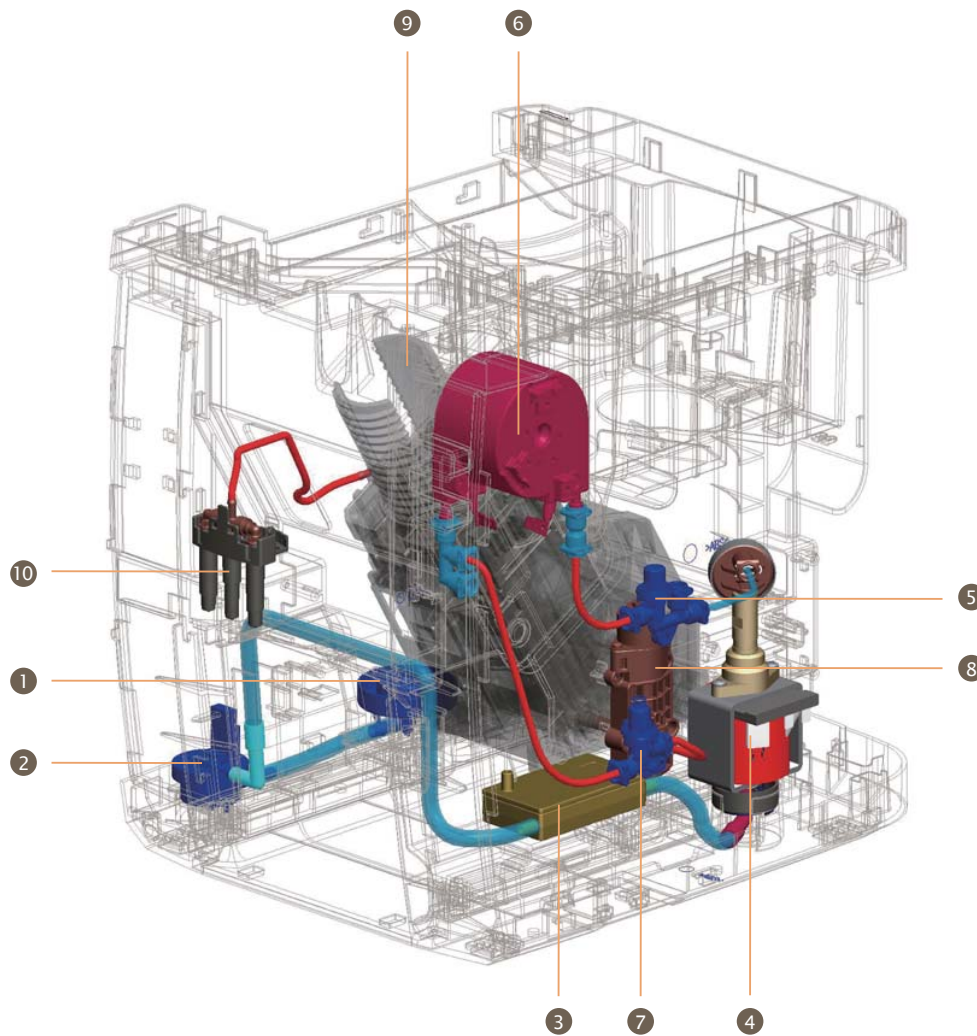

- | | | | |
|---|--------------------|----|--------------------|
| 1 | Valve support | 6 | Coffee thermoblock |
| 2 | Flowmeter | 7 | Dispenser valve 2W |
| 3 | Condensator | 8 | Drainage valve |
| 4 | Pump | 9 | Brew unit |
| 5 | Dispenser valve 3W | 10 | Export |

2.3.3 Water circuit for making steam

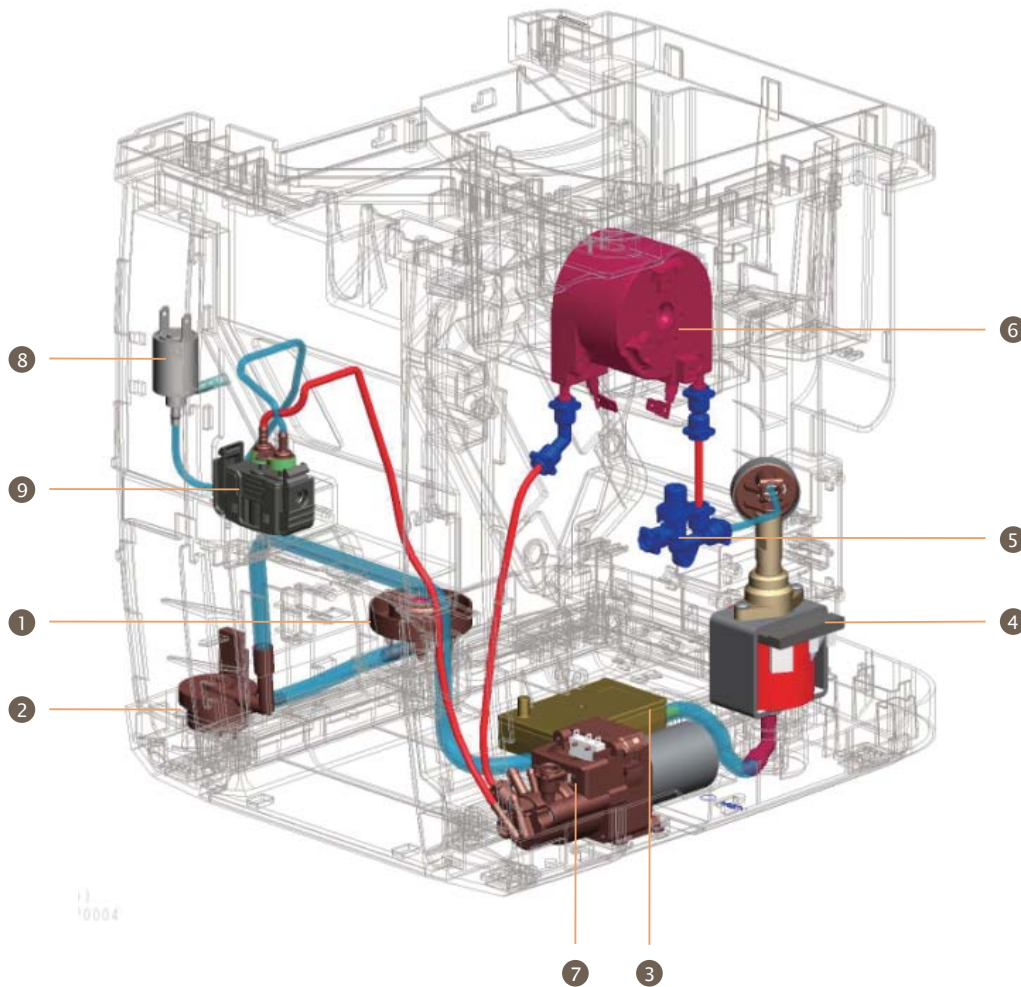

- | | |
|----------------------|---------------------|
| ① Valve support | ⑥ Steam thermoblock |
| ② Flowmeter | ⑦ Dispenser valve |
| ③ Condensator | ⑧ Solenoid valve |
| ④ Pump | ⑨ Foam rubber |
| ⑤ Dispenser valve 3W | |

2.3.4 Water circuit for making hot water

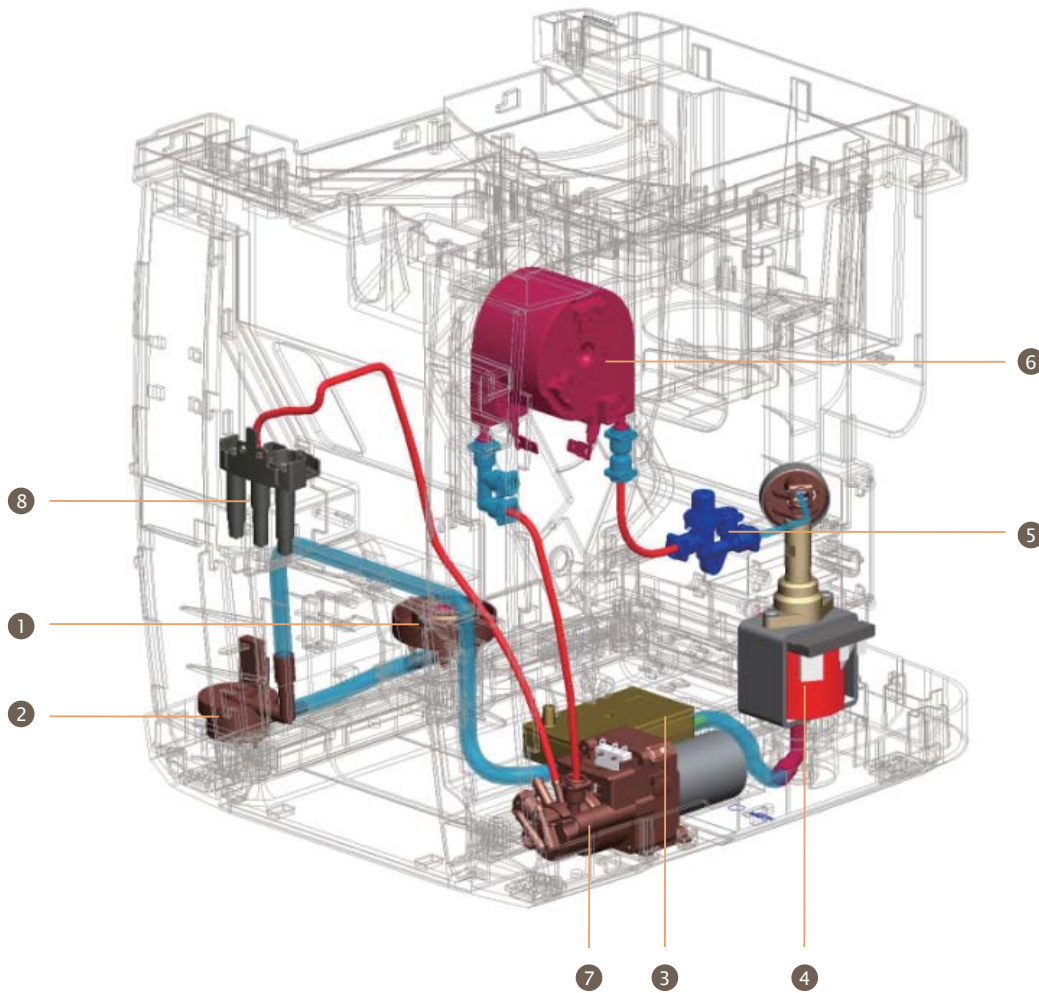

- | | | | |
|---|---------------|---|--------------------|
| ① | Valve support | ⑤ | Dispenser valve 3W |
| ② | Flowmeter | ⑥ | Coffee thermoblock |
| ③ | Condensator | ⑦ | Dispenser valve |
| ④ | Pump | ⑧ | Export |

2.4 Schematic circuit diagram

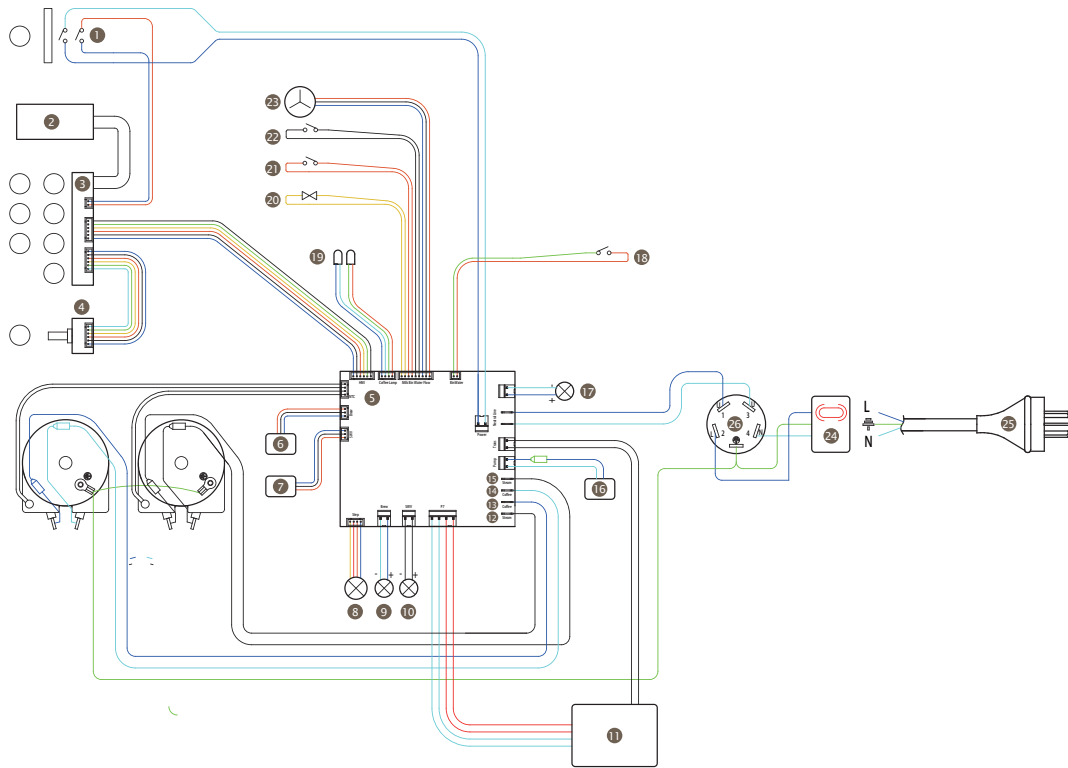

- | | |
|-----------------------------|---|
| ① Power switch | ⑭ Coffee fused-cord |
| ② OLED screen | ⑮ Steam fused-cord |
| ③ HMI | ⑯ Pump |
| ④ Rotary PCB | ⑰ Grinder motor |
| ⑤ NTC | ⑱ Terminal |
| ⑥ Feedback device | ⑲ LED×2 |
| ⑦ Microswitch | ⑳ Valve |
| ⑧ Stepper motor | ㉑ Reed sensor |
| ⑨ Motor for dispenser valve | ㉒ Drip tray microswitch |
| ⑩ Geared motor | ㉓ Flowmeter |
| ⑪ Transformer | ㉔ Line pencil connector(contains 10A fuse) |
| ⑫ Steam fused-cord | ㉕ Power line |
| ⑬ Coffee fused-cord | ㉖ Power filter |

2.5 Technical data

Total voltage/power

China	220V/50HZ 1200W
Europe	230V/50HZ 1400W

Approvals	CCC,CB,GS,CE
-----------	--------------

Power ratings

Thermoblock	220V 1200W
Pump	230V/50HZ 48W ULKA EP4
Grinder motor	DC 220V
Drive motor	DC 24V
Dispenser valve motor	DC 24V
Solenoid valve	DC 24V

Capacities

Water tank	1.8L
Coffee grounds container	15 Pieces
Coffee bean container	250g
Coffee powder volume for brew unit	MIN 5g; MAX 14g

Various data

Dimensions (length×width×height)	450×302×370 mm
Cable Length	approx 1.5 m
Net weight	approx 12.6kg

3. Troubleshooting check list

3.1 Troubleshooting check list

Item	Confirmation	No.	Problem	Prob-ability	No.	Cause	Remedy	Remarks				
3.1	Examine external damage of coffee machine	3.1.1	External parts are broken or damaged				YES - If necessary - replace the external parts NO - continue to 3.1.2	Disassemble the external parts according to 4.2.1				
		3.1.2	Power cord damaged				YES - replace powder cord	Disassemble the powder cord according to 4.2.2				
3.2	Examine the external moving parts	3.2.1	Drip tray can not be installed in place		3.2.1.1	Much coffee powder left on the base	YES - take out the drip tray, observe if there are lots of coffee powder on the base, clean the rest coffee powder NO - continue to 3.2.1.2					
					3.2.1.2	Brew unit does not reset	YES - 1. Take away the coffee ground container 2. Insert the drip tray into the coffee machine 3. Press ON/OFF 4. Take out the drip tray after the coffee machine reset and the screen appears "HEATING" 5. Put the coffee groud container on the drip tray and insert them into the coffee machine again NO - continue to 3.2.1.3					
					3.2.1.3	Drip tray group components damaged	YES - replace the components	Replace or repair the damaged components according to the drip tray explosive view 8810101017				
			3.2.2	Drip tray can not be taken out		3.2.2.1	Export blocked the drip tray	YES - move the export up NO - continue to 3.2.2.2				
					3.2.2.2	Brew unit does not reset, abnormal power off	YES - take the drip tray out when the machine in READY state NO - continue to 3.2.2.3	Restart more times if once is not enough				
		The following should be repaired by disassembling the machine										
					3.2.2.3	Coffee grounds blocked the brew unit	YES - 1. Power on and power off for more than 2 times. 2. If tray can not be take out disassemble and clean the coffee grounds inside the brew unit	Disassemble the brew unit group and clean the coffee grounds according to 4.3.3				
			3.2.3	Coffee export fall off	The following should be repaired by disassembling the machine							
						Sliding panel of the export is damaged	Replace the sliding panel of the coffee export, item: 79000051	1. Disassemble control panel according to 4.2.8 2. Disassemble control panel components according to 4.3.4 3. Replace or repair the damaged components according to the control and explosive view				

Troubleshooting

Item	Confirmation	No.	Problem	Prob-ability	No.	Cause	Remedy	Remarks		
3.2	Examine the external movable parts	3.2.4	Foam rubber can not be installed		3.2.4.1	Wrong installation for foam rubber group	YES - confirm if the rubber foam installed correct NO - continue to 3.2.4.2			
					3.2.4.2	Foam rubber is damaged	YES - replace 79000054 or 79000055	Replace or repair damaged parts according to foam rubber explosive view 8810101022		
		3.2.5	Water leakage from the bottom when taking out water tank or filling in water tank		3.2.5.1	Valve body is stucked, can not be reset	YES - move valve body in order to make it reset NO - continue to 3.2.5.2			
					The following should be repaired or replaced water tank group					
					3.2.5.2	Components damaged	YES - replace components	Replace or repair damaged components according to water tank explosive view 8810101020		
		3.2.6	Powder container cover can not be covered tightly		3.2.6.1	Lots of coffee powder left below the powder container cover	YES - clean the left coffee powder NO - continue to 3.2.6.2			
					The following should be repaired or replaced powder container cover					
					3.2.6.2	Powder container cover deformed	YES - replace powder container cover 79000123	Replace or repair damaged components according to bean container explosive view 8810101019		
		3.3	Press On/Off to AUTO CHECKING and then to READY	3.3.1	Machine can not be powered on		3.3.1.1	Improper voltage for the machine	YES - use proper voltage for the machine NO - continue to 3.3.1.2	
							3.3.1.2	Confirm if the powder cord connected correct	YES - replug the powder cord to the powder socket NO - continue to 3.3.1.3	
	The following should be repaired by dismatling the machine									
	3.3.1.3					Powder cord damaged	YES - replace powder cord NO - continue to 3.3.1.4	Disassemble and replace components according to 4.2.2		
	3.3.1.4					Powder switch damaged	YES - replace microswitch 73000051 NO - continue to 3.3.1.5	1. Disassemble control panel according to 4.2.8; 2. Disassemble microswitch and replace according to 4.3.4		

Item	Confirmation	No.	Problem	Prob-ability	No.	Cause	Remedy	Remarks			
3.3	Press On/Off to AUTO CHECKING and then to READY	3.3.1	Machine can not be power on		3.3.1.5	The connector between PCB and powder switch does not work	YES - connect or repair power switch connector NO - continue to 3.3.1.6	1. Disassemble control panel according to 4.2.8; 2. Disassemble control panel, repair connection line according to 4.3.4			
					3.3.1.6	Transformer connector fell off or damaged	YES - connect or repair the transformer connector NO - continue to 3.3.1.7	Disassemble right side section according to 4.2.1			
					3.3.1.7	Fuse inside the line pencil connector is damaged	YES - replace the fuse inside the line pencil connector NO - continue to 3.3.1.8	Disassemble back cover according to 4.2.1			
					3.3.1.8	PCBA damaged	YES - replace or repair PCBA, item: 78000006	Disassemble PCBA, replace and repair according to 4.2.12			
				3.3.2	FILL WATER TANK on screen		3.3.2.1	No water in the water tank	YES - fill in the water tank NO - continue to 3.3.2.2		
			3.3.2.2			The water tank does not install in place	YES - place the water tank again NO - continue to 3.3.2.3				
			3.3.2.3			The ball inside the water tank is stucked	YES - clean water tank, knock the place near the ball in order to make the ball move inside water tank NO - continue to 3.3.2.4				
			The following should be replaced or repaired the water tank group								
			3.3.2.4			The ball is fell off	YES - replace water tank group, item: 881010037 NO - continue to 3.3.2.5				
			3.3.2.5			Ball damaged	YES - replace water tank group, item: 8810101026 NO - continue to 3.3.2.6				
			The following should be repaired by dismatling the machine								
			3.3.2.6			Reed sensor damaged	YES - replace reed sensor, item: 73000095 NO - continue to 3.3.2.7				
			3.3.2.7	Connector damaged	YES - connect or repair power switch connector NO - continue to 3.3.2.8						

Troubleshooting

Item	Confirmation	No.	Problem	Prob-ability	No.	Cause	Remedy	Remarks		
3.3	Press On/Off to AUTO CHECKING and then to READY	3.3.2	FILL WATER TANK on screen		3.3.2.8	PCBA damaged	YES - replace or repair PCBA, item: 78000006	Disassemble PCBA, replace and repair according to 4.2.12		
		3.3.3	INSTALL TRAY on screen		3.3.3.1	Lots of coffee powder left on the base	YES - clean rest coffee powder NO - continue to 3.3.3.2			
					3.3.3.2	Brew unit does not reset	YES - take out coffee grounds container, reinstall drip tray NO - continue to 3.3.3.3			
				The following should be repaired by disassembling or changing proper parts						
					3.3.3.3	Coffee grounds container frame damaged	YES - replace coffee grounds container frame item: 79000113 NO - continue to 3.3.3.4	Replace or repair damaged components according to drip tray explosive view 8810101017		
					3.3.3.4	Drip tray microswitch damaged	YES - replace microswitch, item: 73000088 (X3C306N2LB) NO - continue to 3.3.3.5			
					3.3.3.5	Drip tray microswitch connector does not work	YES - connect or repair microswitch connector, item: 78000022 NO - continue to 3.3.3.6			
			3.3.3.6	PCBA damaged	YES - replace or repair PCBA, item: 78000006	Disassemble PCBA, replace and repair according to 4.2.12				
		3.3.4	EMPTY TRAY on screen		3.3.4.1	Drip tray terminal is wet	YES - clean up the terminal NO - continue to 3.3.4.2			
					3.3.4.2	Base terminal is wet	YES - clean up the terminal NO - continue to 3.3.4.3	Disassemble back cover according to 4.2.1		
				The following should be repaired by dismatling the machine						
					3.3.4.3	PCBA damaged	YES - replace or repair PCBA, item: 78000006	Disassemble PCBA, replace and repair according to 4.2.12		
		3.3.5	No water comes from coffee export when CLEANING		3.3.5.1	Stepper motor in drainage valve does not reset(stepper motor still in the drainage position when making coffee)	YES - power off the machine, restart (drainage will be reset when power on the machine) NO - continue to 3.3.5.2			
				The following should be repaired by dismatling the machine						

Item	Confirmation	No.	Problem	Prob-ability	No.	Cause	Remedy	Remarks	
3.3	Press On/Off to AUTO CHECKING and then to READY	3.3.5	No water comes from coffee export when CLEANING		3.3.5.2	Inside pipe connector damaged- water leakage(lots of water on the table)	YES - repair damaged pipe or connector NO - continue to 3.3.5.3		
					3.3.5.3	Drainage valve group damaged	YES - replace drainage valve group NO - continue to 3.3.5.4	1. Disassemble drainage valve group according to 4.2.10; 2. Replace or repair damaged components according to drainage valve group explosive view 8810101006	
					3.3.5.4	Contropistone seal damaged	YES - replace contropistone seal, item: 73000065 NO - continue to 3.3.5.5	1. Dismantle brew unit according to 4.2.3; 2. Replace or repair damaged components according to brew unit explosive view 8810101016	
					3.3.5.5	Brew unit piston seal damaged	YES - replace brew unit coffee brewing unit, item: 8810101023 NO - continue to 3.3.5.6	1. Disassemble brew unit according to 4.2.3; 2. Replace or repair damaged components according to brew unit explosive view 8810101016	
					3.3.5.6	Brew unit water seal damaged	YES - replace brew unit seal, item: 73000035	1. Disassemble brew unit according to 4.2.3; 2. Replace or repair damaged components according to drainage valve group explosive view 8810101006	
					3.3.6.1	Brew unit filter screen clogged	YES - enter menu-MAINTAINCE-CLEAN NO - continue to 3.3.6.2	After cleaning, when drainage starts, if the noise is very loud, it means brew unit filter screen get clogged	
			The following should be repaired by dismatling the machine						
		3.3.6	A little water drops from coffee export when CLEANING (normal volume should be more than 35ml)		3.3.6.2	Inside pipe connector damaged-water leakage(lots of water on the table)	YES - repair damaged pipe or connector NO - continue to 3.3.6.3		
	3.3.6.3			Drainage valve group damaged	YES - replace drainage valve group NO - continue to 3.3.6.4	1. Disassemble drainage valve group according to 4.2.10; 2. Replace or repair damaged components according to drainage valve group explosive view 8810101006			

Troubleshooting

Item	Confirmation	No.	Problem	Prob-ability	No.	Cause	Remedy	Remarks			
3.3	Press On/Off to AUTO CHECKING and then to READY	3.3.6	Little water drops from coffee export when CLEANING (normal volume should be more than 35ml)		3.3.6.4	Contropistone seal damaged	YES - replace brew unit seal, item: 73000065 NO - continue to 3.3.6.5	1. Disassemble brew unit according to 4.2.3; 2. Replace or repair damaged components according to brew unit explosive view 8810101016			
					3.3.6.5	Brew unit piston seal damaged	YES - replace coffee brewing group, item: 8810101023 NO - continue to 3.3.6.6	1. Disassemble brew unit according to 4.2.3; 2. Replace or repair damaged components according to brew unit explosive view 8810101016			
					3.3.6.6	Brew unit seal damaged	YES - replace brew unit seal, item: 73000035	1. Disassemble drainage valve group according to 4.2.10; 2. Replace or repair damaged components according to drainage valve group explosive view 8810101006			
3.4	READY	3.4.1	Touch screen becomes invalid		3.4.1.1	Touch screen with glove or touch screen is dirty	YES - clean the touch screen NO - continue to 3.4.1.2				
				The following should be repaired or replaced by dismatling the machine							
					3.4.1.2	ITO damaged	YES - replace ITO, item: 78000004 NO - continue to 3.4.1.3	1. Disassemble control panel according to 4.2.8; 2. Disassemble control panel components according to 4.3.4; 3. Replace or repair damaged components according to control panel explosive view 8810101007			
					3.4.1.3	HMI damaged	YES - replace and repair HMI, item: 78000002 NO - continue to 3.4.1.4	Refer to 3.4.1.2			
					3.4.1.4	The connector between HMI and PCBA is damaged or dropped	YES - conncect or replace connector, item: 78000024 NO - continue to 3.4.1.5	Refer to 3.4.1.2			
	3.4.1.5	PCBA damaged	YES - replace or repair PCBA, item: 78000006	Disassemble PCBA, replace and repair according to 4.2.12							

Item	Confirmation	No.	Problem	Prob-ability	No.	Cause	Remedy	Remarks		
3.4	READY	3.4.2	Rotary becomes invalid		3.4.2.1	Rotary is stucked so it can not be moved or pressed	YES - replace rotary, item: 79000058 NO - continue to 3.4.2.2	1. Disassemble control panel according to 4.2.8; 2. Disassemble control panel components according to 4.3.4; 3. Replace or repair damaged components according to control panel explosive view 8810101007		
					3.4.2.2	Rotary PCB damaged	YES - replace rotary PCB, item: 78000003 NO - continue to 3.4.2.3	Refer to 3.4.2.1		
					3.4.2.3	The connector between rotary PCB and HMI damaged	YES - replace line pencil, item: 78000013 NO - continue to 3.4.2.4	Refer to 3.4.2.1		
					3.4.2.4	HMI damaged	YES - replace HMI, item: 78000002 NO - continue to 3.4.2.5	Refer to 3.4.2.1		
					3.4.2.5	PCBA damaged	YES - replace or repair PCBA, item: 78000006	Disassemble PCBA, replace and repair according to 4.2.12		
		The following should be repaired by dismatling the machine								
		3.4.3	Rinse button becomes invalid		3.4.3.1	Clean button is stucked or damaged	YES - make the clean button can be pressed or replace damaged button, item: 79000064 NO - continue to 3.4.3.2	1. Disassemble control panel according to 4.2.8; 2. Disassemble control panel components according to 4.3.4; 3. Replace or repair damaged components according to control panel explosive view 8810101007		
					3.4.3.2	Press button on HMI damaged	YES - replace HMI, item: 78000002 NO - continue to 3.4.3.3	Refer to 3.4.5.1		
					3.4.3.3	HMI damaged	YES - replace HMI, item: 78000002 NO - continue to 3.4.3.4	Refer to 3.4.5.1		
					3.4.3.4	Connection line between HMI and PCBA damaged or dropped	YES - connect or replace connection line, item: 78000024 NO - continue to 3.4.3.5	Refer to 3.4.5.1		
					3.4.3.5	PCBA damaged	YES - replace or repair PCBA, item: 78000006	Disassemble PCBA, replace and repair according to 4.2.12		
		Conduct the following confirmation after reset								

Troubleshooting

Item	Confirmation	No.	Problem	Prob-ability	No.	Cause	Remedy	Remarks
3.5	Use coffee beans to make coffee	3.5.1	The grinder unit does not work(the screen shows working but no sounds from the grinder unit)		The following should be repaired by dismatling the machine			
				3.5.1.1	Grinder group motor terminal or connection line damaged or dropped	YES - connect or replace connection line, item: 78000020 NO - continue to 3.5.1.2	1. Disassemble grinder group according to 4.2.7; 2. Disassemble grinder group according to 4.2.3	
				3.5.1.2	Grinder motor fuse damaged on PCBA	YES - replace grinder motor fuse on PCBA NO - continue to 3.5.1.3		
				3.5.1.3	Grinder motor damaged	YES - replace grinder motor, item: 73000024 NO - continue to 3.5.1.4	1. Disassemble grinder group according to 4.2.7; 2. Disassemble grinder group according to 4.3.3	
		3.5.1.4	PCBA grinder motor control circuit or components damaged	YES - replace or repair PCBA, item: 78000006	Disassemble PCBA, replace and repair according to 4.2.12			
		3.5.2	FILL BEANS displays on the screen after grinding (grinder unit works)	3.5.2.1	Coffee beans are too oil and sticked to the entrance of the grinder	YES - stir coffee beans inside the bean container NO - continue to 3.5.2.2		
				3.5.2.2	Use over roasted coffee beans	YES - replace to the finest level by adjusting coffee powder adjustment, continue to make 2 cups of coffee, the 3rd cup will be normal NO - continue to 3.5.2.3		
				3.5.2.3	Use wet coffee beans	YES - choose normal dry coffee beans NO - continue to 3.5.2.4		
	3.5.2.4			Coffee powder channel is clogged	YES - use provided coffee powder spoon to unclog NO - continue to 3.5.2.5			
				The following should be repaired by dismatling the machine				
	3.5.2.5			Grinder entrance is sticked	YES - take out bean container, and clean grinder entrance NO - continue to 3.5.2.6	Take out bean container according to 4.2.1		
	3.5.2.6			Screw pin worm drive is loose, the gap between conical burr and upper burr	YES - take out bean container, lock screw pin worm drive, item: 79000020 NO - continue to 3.5.2.7	Refer to 3.5.2.5		
	3.5.2.7			The gap between conical burr and upper burr lessens or no gap	YES - lock conical burr fastener,if support lower grinder damaged-replace it, item:7900019 NO - continue to 3.5.2.8	1. Take out grinder group according to 4.2.7; 2. Disassemble grinder group according to 4.3.3 3. According to grinder group explosive view 881010002, replace or repair damaged components		
	3.5.2.8	Water into grinder group	YES - take out grinder group, clean or replace conical burr and upper burr, item: 73000023 and 73000022 NO - continue to 3.5.2.9					

Item	Confirmation	No.	Problem	Prob-ability	No.	Cause	Remedy	Remarks			
3.5	Use coffee beans to make coffee	3.5.2	FILL BEANS displays on the screen after grinding (grinder unit works)		3.5.2.9	Grinder group is stucked	YES - take out foreign object from grinder group NO - continue to 3.5.2.10	If conical burr and upper burr is stucked by foreign object, there will be different regular noise when the conical buur and upper burr does not work			
					3.5.2.10	Gear group or gear box damaged	YES - replace parts in grinder group	1. Disassemble grinder group according to 4.2.7; 2. Disassemble grinder group according to 4.3.3 3. According to grinder group explosive view 8810101002, replace or repair damaged components			
		3.5.3	No coffee comes out from coffee export		3.5.3.1	Drainage valve stepper motor does not reset(stepper is still in drainage position when making coffee)	YES - power off the machine, restart (drainage will be reset when power on the machine) NO - continue to 3.5.3.2				
					The following should be repaired by dismatting the machine						
					3.5.3.2	Inside pipe connector damaged or dropped-water leakage(lots of water on the table)	YES - repair damaged water pipes or pipe connector in drainage valve group NO - continue to 3.5.3.3				
					3.5.3.3	Inside pipe connector damaged or dropped-coffee leakage(lots of coffee on the table)	YES - repair pipes or pipe connector at the back of brew unit continue to - 3.5.3.4				
					3.5.3.4	Drainage valve group damaged, no water comes to brew unit; water drops to drip tray directly from drainage valve	YES - replace drainage valve group NO - continue to 3.5.3.5	1. Disassemble drainage valve group according to 4.2.10; 2. Replace or repair damaged components according to drainage valve group explosive view 8810101006			
					3.5.3.5	Contropistone seal damaged, coffee comes out from the gap between coffee brewing box and contropistone	YES - replace contropistone seal, item: 73000065 NO - continue to 3.5.3.6	1. Disassemble brew unit according to 4.2.3; 2. Replace or repair damaged components according to brew unit explosive view 8810101016			
					3.5.3.6	Brew unit piston seal damaged	YES - replace coffee brewing group, item: 8810101023 NO - continue to 3.5.3.7	Refer to 3.5.3.5			
					3.5.3.7	Seal in brew unit damaged	YES - replace seal, item: 73000035 NO - continue to 3.5.3.8	1. Disassemble drainage valve group according to 4.2.10; 2. Replace or repair damaged components according to drainage valve group explosive view 8810101006			

Troubleshooting

Item	Confirmation	No.	Problem	Prob-ability	No.	Cause	Remedy	Remarks		
3.5	Use coffee beans to make coffee	3.5.3	No coffee comes out from coffee export		3.5.3.8	Brew unit parts damaged; when making coffee ,coffee brewing box can not be closed exactly	YES - replace damaged parts in brew unit	1. Disassemble brew unit according to 4.2.3; 2. Replace or repair damaged components according to brew unit explosive view 8810101016		
		3.5.4	Coffee temperature is too low(below 70°C)		3.5.4.1	The temperature of the cup is too low	YES - preheat coffee cup or increase the temperature of environment NO - continue to 3.5.4.2			
					3.5.4.2	The temperature of the water is too low	YES - use the pure water that around 25°C NO - continue to 3.5.4.3			
					3.5.4.3	The temperature is low, or standby time is too long; brew unit and water circuit is cold	YES - the temperature from the 3rd cup will meet the standard NO - continue to 3.5.4.4			
					3.5.4.4	Coffee machine needs descale (deposit decreased the efficiency of the thermoblock)	YES - descale	Descale according to 5.2.2		
		3.5.5	Coffee temperature is too high(more than 89°C)		3.5.5.1	NTC loose or unfixed	YES - fix NTC NO - continue to 3.5.5.2			
					3.5.5.2	NTC thermistor damaged	YES - replace NTC thermistor, item: 73000074 NO - continue to 3.5.5.3	Replace or repair damaged components according to thermoblock group explosive view 8810101025		
					3.5.5.3	Program or PCBA damaged	YES - replace or repair PCBA, item: 78000006	Disassemble PCBA,replace and repair according to 4.2.12		
		3.5.6	Coffee volume is too little (the volume of Espresso is less than 25ml)		3.5.6.1	Coffee machine needs descale (deposit makes pipes inside the machine nearly clogged)	YES - descale NO - continue to 3.5.6.2	Descale according to 5.2.2		
					3.5.6.2	Drainage valve stepper motor does not reset (when making coffee, stepper motor is still in drainage position)	YES - power off coffee machine, restart (drainage valve will be reset automatically when restart) NO - continue to 3.5.6.3			
				The following should be repaired by dismatling the machine						
					3.5.6.3	Inside pipe connector damaged or dropped-water leakage (water on the table)	YES - repair damaged pipe or connector in front of the drainage valve group NO - continue to 3.5.6.4			
					3.5.6.4	Inside pipe connector damaged or dropped leads to coffee leakage (lots of coffee on the table)	YES - repair pipe or connector at the back of brew unit NO - continue to 3.5.6.5			

Item	Confirmation	No.	Problem	Prob-ability	No.	Cause	Remedy	Remarks
3.5	Use coffee beans to make coffee	3.5.6	Coffee volume is too little (the volume of Espresso is less than 25ml)		3.5.6.5	Drainage valve group damaged, no water comes to brew unit, dropped to drip tray from drainage valve directly	YES - replace drainage valve group NO - continue to 3.5.6.5	1. Disassemble drainage valve group according to 4.2.10; 2. Replace or repair damaged components according to drainage valve group explosive view 8810101006
					3.5.6.6	Contropistone seal damaged, coffee sprays from the gap between coffee brewing box and contropistone	YES - replace contropistone seal, item: 73000065 NO - continue to 3.5.6.7	1. Disassemble brew unit according to 4.2.3; 2. Replace or repair damaged components according to brew unit explosive view 8810101016
					3.5.6.7	Brew unit piston seal damaged	YES - replace coffee brewing group, item: 8810101023 NO - continue to 3.5.6.8	Refer to 3.5.6.6
					3.5.6.8	Seal in brew unit damaged	YES - replace water seal, item: 73000035 NO - continue to 3.5.6.9	Refer to 3.5.6.6
					3.5.6.9	Brew unit parts damaged; when making coffee, coffee brewing box can not be closed exactly	YES - replace damaged parts in brew unit	Refer to 3.5.6.6
		3.5.7	Too much coffee (the volume of Espresso is more than 100ml)		3.5.7.1	Flowmeter damaged, magnet inside the flowmeter does not work	YES - replace flowmeter, item: 73000089 NO - continue to 3.5.7.2	Disassemble flowmeter and replace according to 4.2.5
					3.5.7.2	Program or PCBA damaged	YES - replace or repair PCBA, item: 78000006	Disassemble PCBA, replace and repair according to 4.2.12
		3.5.8	Coffee is too soft, no crema on the top		3.5.8.1	Improper coffee beans or coffee powder	YES - use proper, fresh coffee beans or coffee powder NO - continue to 3.5.8.2	
					3.5.8.2	Coffee powder is too rough	YES - adjust the grinder adjustment rotate to the finest state, continue to make 2 cups of coffee, the 3rd cup will meet the standard NO - continue to 3.5.8.3	
					The following should be repaired by dismantling the machine			
				3.5.8.3	Grinder group damaged or end of life	YES - replace grinder group parts	1. Disassemble PCBA, replace and repair according to 4.2.12; 2. Disassemble grinder group according to 4.2.7; 3. Disassemble grinder group according to 4.3.3 according to grinder group explosive view 8810101002 4. Replace or repair damaged components	

Troubleshooting

Item	Confirmation	No.	Problem	Prob-ability	No.	Cause	Remedy	Remarks
3.6	Use coffee powder to make coffee	3.6.1	LACK OF POWDER displays on the screen		3.6.1.1	Not enough coffee powder	YES - use Kalem provided coffee spoon, fill one full spoon of coffee powder NO - continue to 3.6.1.2	
					3.6.1.2	Coffee powder channel is clogged	YES - open powder container cover, clear coffee powder channel	
		3.6.2	No coffee comes out from coffee export			Refer to 3.5.3		
		3.6.3	Coffee temperature is too low(below 75°C)			Refer to 3.5.4		
		3.6.4	Coffee temperature is too high(more than 75°C)			Refer to 3.5.5		
		3.6.5	Coffee volume is too little (the volume of Espresso is less than 25ml)			Refer to 3.5.6		
		3.6.6	Coffee volume is too much (the volume of Espresso is more than 100ml)			Refer to 3.5.7		
		3.6.7	Coffee is too soft, no crema on the top			Refer to 3.5.8		
3.7	The process to make hot water	3.7.1	No water comes out from water export		3.7.1.1	Coffee machine needs descale(deposit makes pipes inside the machine nearly clogged)	YES - descale NO - continue to 3.7.1.2	Descalce according to 5.2.2
					The following should be repaired by dismatling the machine			
					3.7.1.2	Dispenser valve 2W damaged and does not work (water dropped to drip tray)	YES - repair or replace dispenser valve 2W, item: 8810101004 NO - continue to 3.7.1.3	Disassemble dispenser valve 2W according to 4.2.13
					3.7.1.3	Inside pipe connector damaged or dropped (water leaks to the table)	YES - connect or replace leakage position NO - continue to 3.7.1.4	

Item	Confirmation	No.	Problem	Prob-ability	No.	Cause	Remedy	Remarks		
3.7	The process to make hot water	3.7.1	No water comes out from water export		3.7.1.4	Drainage damaged	YES - replace damaged drainage valve	1. Disassemble dispenser valve according to 4.2.9; 2. Disassemble dispenser valve according to 4.3.2; 3. Replace or repair damaged components according to dispenser valve explosive view 8810101001		
		3.7.2	The volume of hot water is too little		3.7.2.1	Coffee machine needs descale (deposit makes pipes inside the machine nearly clogged)	YES - descale NO - continue to 3.7.2.2			
				The following should be repaired by dismatling the machine						
				3.7.2.2	Dispenser valve 2W damaged and does not work (water dropped to drip tray)	YES - repair or replace dispenser valve 2W, item: 8810101004 NO - continue to 3.7.2.3	Disassemble dispenser valve 2W according to 4.2.13			
				3.7.2.3	Inside pipe connector damaged or dropped (water leaks to the table)	YES - connect or replace leakage position NO - continue to 3.7.2.4				
		3.7.3	The volume of hot water is too much	3.7.3.1	Flowmeter damaged,magnet does not work	YES - replace flowmeter NO - continue to 3.7.3.2	Disassemble flow meter and replace according to 4.2.5			
				3.7.3.2	Program or PCBA damaged	YES - replace or repair PCBA, item: 78000006	Disassemble PCBA,replace and repair according to 4.2.12			
3.7.4	Hot water temperature is too low				Refer to 3. 5.4					
3.8	The process to make cappuccino	3.8.1	Milk can not be sucked up			Refer to 3.10.1				
		3.8.2	It is milk lastead of cream during cappuccino process			Refer to 3. 11.2				
		3.8.3	Problems occur during coffee process when making Cappuccino			Refer to 3. 5				
3.9	The procee to make Latte	3.9.1	All the problems refer to 3.8							
3.10	The process to make hot milk	3.10.1	Milk can not be sucked up		3.10.1.1	Improper milk	YES - confirm if the milk is fresh whole milk NO - continue to 3.10.1.2			
					3.10.1.2	No steam,steam nozzle clogged (there is pumping water noise inside the machine-pump works)	YES - clear or replace steam nozzle, item: 79000056 NO - continue to 3.10.1.3	According to foam rubber explosive view 8810101022		

Troubleshooting

Item	Confirmation	No.	Problem	Prob-ability	No.	Cause	Remedy	Remarks		
3.10	The process to make hot milk	3.10.1	Milk can not be sucked up		3.10.1.3	Milk pipe clogged	YES - clear or replace milk pipe NO - continue to 3.10.1.4			
					3.10.1.4	Foam rubber clogged	YES - clear or replace foam rubber, item: 79000187 NO - continue to 3.10.1.5	According to foam rubber explosive view 881010022		
					3.10.1.5	Air pipe loose or damaged	YES - connect or replace air pipe, item: 73000120 NO - continue to 3.10.1.6	1. Disassemble valve according to 4.2.6; 2. Replace or repair damaged components according to valve group explosive view 8810101012		
					3.10.1.6	Steam seal damaged	YES - replace steam seal, item: 73000044 NO - continue to 3.10.1.7	1. Disassemble control panel according to 4.2.8; 2. Disassemble control panel components according to 4.3.4; 3. Replace or repair damaged components according to control panel explosive view 8810101007		
				The following should be repaired by dismatling the machine						
					3.10.1.7	Steam sprays from internal coffee machine	YES - repair or replace water pipe connector NO - continue to 3.10.1.8			
			3.10.1.8	Dispenser valve damaged	YES - replace damaged dispenser valve parts	1. Disassemble dispenser valve according to 4.2.9; 2. Disassemble dispenser valve according to 4.3.2; 3. Replace or repair damaged components according to dispenser valve explosive view 8810101001				
			3.10.2	The cream sprayed out		3.10.2.1	Improper milk	YES - confirm if the milk is fresh whole milk NO - continue to 3.10.2.2		
					3.10.2.2	Foam rubber is dirty	YES - take out foam rubber and clean it			
			3.10.3	Milk temperature is too low		3.10.3.1	Improper milk	YES - use milk with the temperature over 10 C NO - continue to 3.10.3.2		
	3.10.3.2	Foam rubber is dirty			YES - take out foam rubber and clean it					
3.11	The process to make cream	3.11.1	Milk can not be sucked up			Refer to 3.10.1				
		3.11.2	It is milk instead of cream inside the cup		3.11.2.1	Foam rubber air hole is clogged	YES - clean foam rubber NO - continue to 3.11.2.2			
					3.11.2.2	Inlet port is clogged	YES - replace valve air inlet, item: 79000188 NO - continue to 3.11.2.3	1. Disassemble valve according to 4.2.6; 2. Replace or repair damaged components according to valve group explosive view 8810101012		

Item	Confirmation	No.	Problem	Prob-ability	No.	Cause	Remedy	Remarks
3.11	The process to make cream	3.11.2	It is milk instead of cream inside the cup		3.11.2.3	Valve damaged	YES - replace valve, item: 73000057 NO - continue to 3.11.2.4	Refer to 3.11.2.2
					3.11.2.4	Air pipe clogged	YES - replace air pipe, item: 73000120 NO - continue to 3.11.2.5	Refer to 3.11.2.2
					3.11.2.5	PCBA damaged	YES - replace or repair PCBA, item: 78000006	Disassemble PCBA, replace and repair according to 4.2.12
3.12	Leakage checking	3.12.1	Lots of water on the table		3.12.1.1	Water leakage between water inlet valve and water tank	YES - replace or repair water inlet valve seal NO - continue to 3.12.1.2	1. Disassemble water inlet valve group according to 4.2.4 2. Replace or repair damaged components according to water inlet valve group explosive view 8810101011
					3.12.1.2	Water sensor in front of drip tray is dirty	YES - clean water sensor NO - continue to 3.12.1.3	
					3.12.1.3	Water sensor inside the drip tray has fell off	YES - insert water sensor, item: 79000117 NO - continue to 3.12.1.4	According to drip tray group explosive view 8810101017
					3.12.1.4	Water sensor deformed	YES - replace water sensor, item: 79000160 NO - continue to 3.12.1.5	According to frame explosive view 8810101021
					3.12.1.5	Line pencil does not work	YES - repair connector, item: 78000021 NO - continue to 3.12.1.6	Disassemble appearance components according to 4.2.1
					3.12.1.6	PCBA damaged	YES - replace or repair PCBA, item: 78000006 NO - continue to 3.12.1.7	Disassemble PCBA, replace and repair according to 4.2.12
					3.12.1.7	Connector or pipe damaged- water leakage	YES - replace connector or pipe	
3.13	Problem after press ON/OFF to CLEANING till power off		Problems refer to 3.3					
3.14	Decalcifying							Descale according to 5.2.1
3.15	cleaning							Clean coffee machine according to 5.2.2

Troubleshooting

Item	Confirmation	No.	Problem	Prob-ability	No.	Cause	Remedy	Remarks
3.16	ERROR 1-7Coffee machine needs to be repaired when there is ERROR on the screen	3.16.1	ERROR 1 no power in thermoblock or the thermoblock temperature fuse damaged		3.16.1.1	System testing Malfunction	YES - Restart the machine NO - continue to 3.16.1.2	
					3.16.1.2	Coffee thermoblock connection line fell off or damaged	YES - repair or replace coffee thermoblock connection line; item: 78000014 and 78000015 NO - continue to 3.16.1.3	According to explosive view 8810101025
					3.16.1.3	Coffee thermoblock does not work	YES - replace coffee thermoblock, item: 79000132 NO - continue to 3.16.1.4	1. Disassemble thermoblock group according to 4.2.15 2. Replace damaged components according to thermoblock group explosive view 8810101025
					3.16.1.4	Coffee thermoblock connection line fell off or damaged	YES - repair or replace steam thermoblock connection line, item: 78000016 and 78000017 NO - continue to 3.16.1.5	According to explosive view 8810101025
					3.16.1.5	Steam thermoblock does not work	YES - replace steam thermoblock, item: 79000132	1. Disassemble thermoblock group according to 4.2.15 2. Replace damaged components according to thermoblock group explosive view 8810101025
		3.16.2	ERROR 2 NTC damaged		3.16.2.1	System testing Malfunction	YES - Restart the machine NO - continue to 3.16.2.2	
					3.16.2.2	Coffee thermoblock NTC damaged	YES - replace NTC, item: 73000074 NO - continue to 3.16.2.3	Replace damaged components according to explosive view 8810101025
					3.16.2.3	Steam thermoblock NTC damaged	YES - replace NTC, item: 73000074 NO - continue to 3.16.2.4	Refer to 3.16.2.1
					3.16.2.4	NTC connection line does not work	YES - connect or replace connection line, item: 73000074	Refer to 3.16.2.1
		3.16.3	ERROR 6 press 5 times UNIT EMPTY, and it still can not be solved by pressing the rotary-water circuit is		3.16.3.1	Pump and flowmeter connection line dropped or damaged	YES - repair or replace pump and flowmeter connection line, item: 78000012 and 78000022 NO - continue to 3.16.3.2	Disassemble appearance according to 4.2.1
					3.16.3.2	Pump damaged	YES - repair or replace pump, item: 73000053 NO - continue to 3.16.3.3	1. Disassemble pump group according to 4.2.11; 2. Replace or repair damaged components according to pump group explosive view 8810101011
					3.16.3.3	Flowmeter clogged or damaged	YES - repair or replace flowmeter, item: 73000089 NO - continue to 3.16.3.4	Disassemble flowmeter according to 4.2.5

Item	Confirmation	No.	Problem	Prob-ability	No.	Cause	Remedy	Remarks		
3.16	ERROR 1-7Coffee machine needs to be repaired when there is ERROR on the screen	3.16.3	ERROR 6 press 5 times UNIT EMPTY, and it still can not be solved by pressing the rotary-water circuit is		3.16.3.4	Dispenser valve internal structure damaged	YES - replace damaged parts NO - continue to 3.16.3.5	Refer to 3.16.3.1		
					3.16.3.5	Water circuit clogged	YES - repair or clear water circuit NO - continue to 3.16.3.6			
					3.16.3.6	Pipe damaged	YES - replace damaged pipe			
		3.16.4	ERROR 7 communication mistakes between PCBA and HMI		3.16.7.1	Connection line between HMI and PCBA loose	YES - connect or replace connection line between HMI and PCBA, item: 78000024 NO - continue to 3.16.7.2	1. Disassemble control panel according to 4.2.8; 2. Disassemble control panel components according to 4.3.4; 3. Replace or repair damaged components according to control panel explosive view 8810101007		
					3.16.7.2	HMI damaged	YES - repair or replace HMI, item: 78000002 NO - continue to 3.16.7.3	Refer to 3.16.7.1		
					3.16.7.3	PCBA damaged	YES - replace or repair PCBA, item: 78000006	Disassemble PCBA, replace and repair according to 4.2.12		
		3.17	Information reminding	3.17.1	UNIT EMPTY			Water circuit lack of water	YES - press rotary to fill unit	Press rotary till FILL UNIT accomplished
3.17.2	PRESSURE HIGH (protective program during making coffee)				3.17.2.1	Use deep roasted coffee beans or use over fine coffee powder	YES - use suitable coffee bean or coffee powder NO - continue to 3.17.2.2			
					3.17.2.2	Filter screen of brew unit clogged	YES - clean brew unit NO - continue to 3.17.2.3	Clean coffee machine according to 5.2.2		
				The following should be repaired by maintainers						
					3.17.2.3	Coffee powder clogged filter screen completely	YES - take out drip tray, clean filter screen	Clean coffee machine according to 5.2.3		
3.17.3	TEMPERATURE HIGH					System testing Malfunction	YES - half an hour after restart the machine			
3.17.4	Error3 (VALVE RESET RESTART				3.17.4.1	System testing Malfunction	YES - restart the machine NO - continue to 3.17.4.2			
				The following should be repaired by maintainers						
					3.17.4.2	PCBA damaged	YES - replace or repair PCBA, item: 78000006 NO - continue to 3.17.4.3	Disassemble PCBA, replace and repair according to 4.2.12		
					3.17.4.3	Dispenser valve microswitch damaged	YES - replace microswitch NO - continue to 3.17.4.4	1. Disassemble dispenser valve according to 4.2.9; 2. Disassemble dispenser valve according to 4.3.2		
	3.17.4.4	Dispenser valve microswitch line pencil fell off	YES - replace or repair dispenser valve line pencil, item: 78000008 NO - continue to 3.16.3.3	Refer to 3.17.4.3						

Troubleshooting

Item	Confirmation	No.	Problem	Prob-ability	No.	Cause	Remedy	Remarks		
3.17	Information reminding	3.17.4	Error3 (VALVE RESET RESTART)		3.17.4.5	Dispenser valve motor for damaged	YES - replace motor, item: 73000010 NO - continue to 3.17.4.6	Refer to 3.17.4.3		
					3.17.4.6	Dispenser valve internal structure damaged	YES - replace damaged parts	Refer to 3.17.4.3		
		3.17.5	BREW UNIT RESET RESTART MACHINE		3.17.5.1	System testing Malfunction	YES - restart the machine NO - continue to 3.17.5.2			
					3.17.5.2	Brew unit is dirty, lots of coffee powder in contropistone	YES - clean and maintain brew unit NO - continue to 3.17.5.3	Clean coffee machine according to 5.2.2		
					The following should be repaired by maintainers					
					3.17.5.3	PCBA damaged	YES - replace or repair PCBA, item: 78000006 NO - continue to 3.17.5.4	Disassemble PCBA, replace and repair according to 4.2.12		
					3.17.5.4	Feedback device damaged	YES - repair or replace coder circuit board, item: 78000005 NO - continue to 3.16.4.3	Replace or repair damaged components according to feedback device explosive view 8810101013		
					3.17.5.5	Brew unit parts damaged	YES - replace or repair brew unit parts NO - continue to 3.16.4.4	1. Disassemble brew unit according to 4.2.3; 2. Replace or repair damaged components according to brew unit explosive view 8810101016		
			3.17.5.6	Transmission group parts damaged	YES - replace or repair transmission group parts	1. Disassemble geared motor group according to 4.2.17 2. Replace or repair damaged components according to geared motor group explosive view 8810101014				



3.2 Check list for minor failure

3.2.1 Function



3.2.1.1 Reed sensor function

If there is water in water tank, but the screen displays FILL WATER TANK, put a magnet in left side section as the picture shows: if the screen does not display FILL WATER TANK anymore- water tank components damaged- replace components; If the screen still displays FILL WATER TANK- internal line fault- disassemble and repair the machine.

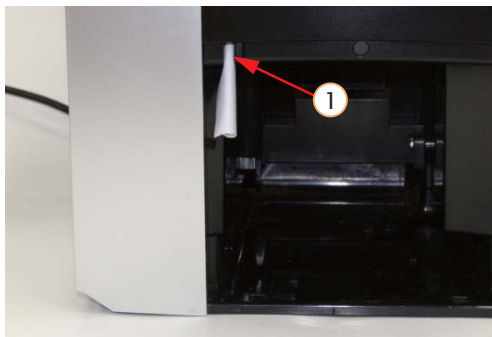

3.2.1.2 Drip tray microswitch function

If drip tray installed correctly, but the screen displays INSTALL TRAY-fill in a piece of paper in the position of microswitch as the picture shows and touch microswitch: if the screen does not display INSTALL TRAY any more-drip tray components damaged- replace components; if the screen still display NSTALL TRAY-internal line fault- disassemble and repair the machine.

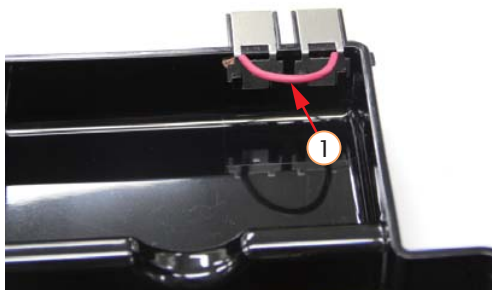

3.2.1.3 Drip tray terminal function

Use a wire to connet the terminal on drip tray as the picture shows, and install to the machine correcttly. if the screen reminds EMPTY TRAY- terminal function is all right; If the screen does not remind EMPTY TRAY-internal line fault- disassemble and repair the machine.

3.2.1.4 Press button

Operation all the function buttons on the control panel to judge if the press buttons are all right, and confirm issues and causes according to check list 3.1.

3.2.2 Circuit



3.2.2.1 Check fuse inside line pencil connector

If the fuse is damaged, machine can not be started on.



3.2.2.2 Check grinder motor fuse of PCBA

If fuse damaged, the grinder motor will not work.

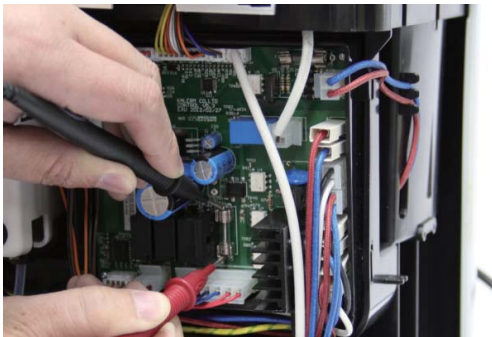

3.2.2.3 Check driving motor fuse of PCBA

If fuse damaged, drainage motor and driving motor will not work.

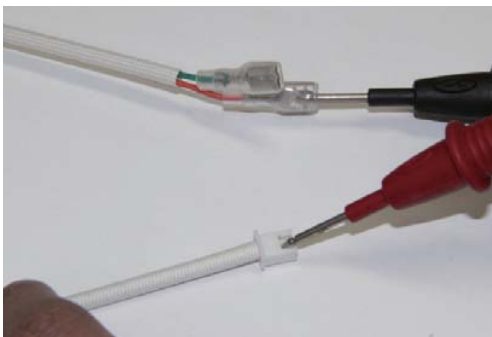

3.2.2.4 Check all the connection lines

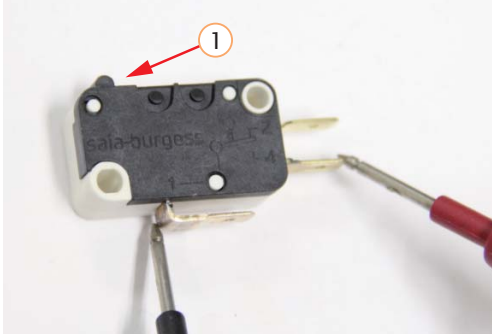

3.2.2.5 Check all switches

The picture shows off-state.

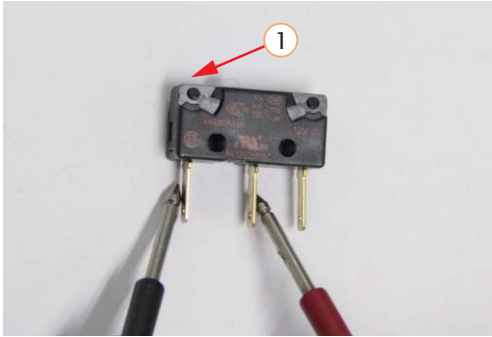

When touch microswitch contactor, it is on-state.

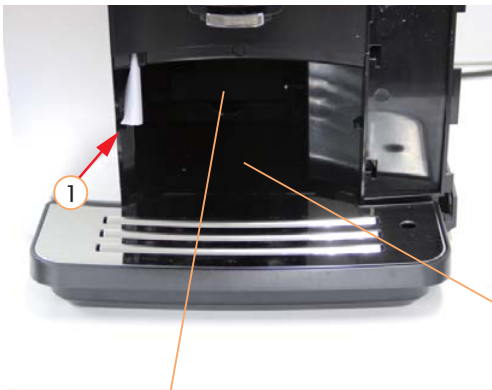

3.2.3. Leakage

Take off drip tray layer board as the picture shows, fill drip tray microswitch with paper, and press rinse button

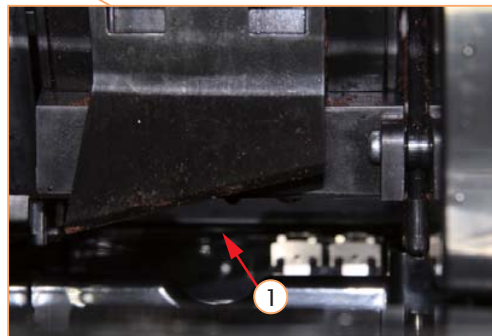
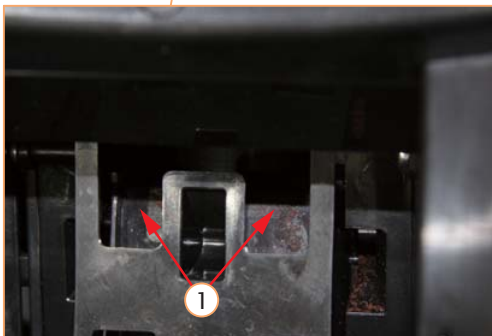

Check leakage of brew unit

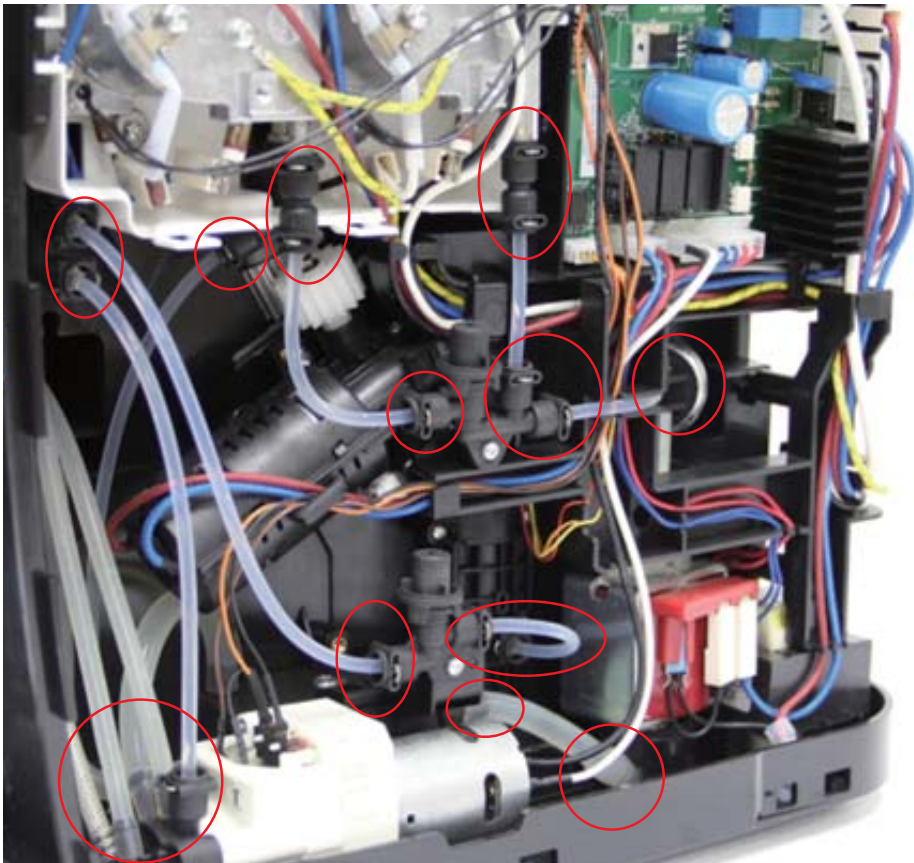

Check leakage of connectors

4. Repair

4.1 Tools preparation



Torx screwdriver (T6,T10,T15,T20,T25)



Slotted type screwdriver (3mm series)



Needle-nose pliers



Multimeter



Electronic scale



Temperature tester

4.2 Disassemble process for components

4.2.1 Disassemble exterior parts

4.2.1.1 Take out movable parts



1. Take out drip tray



2. Take out bean container lid group



3. Take out water tank group

4.2.1.2 Disassemble back cover



1. Rotate the Logo support according to the direction of the arrow



2. Dismantle 2 screws from the bottom of the Logo support



3. Take out back cover according to the arrow direction

4.2.1.3 Disassemble front cover right and front cover left

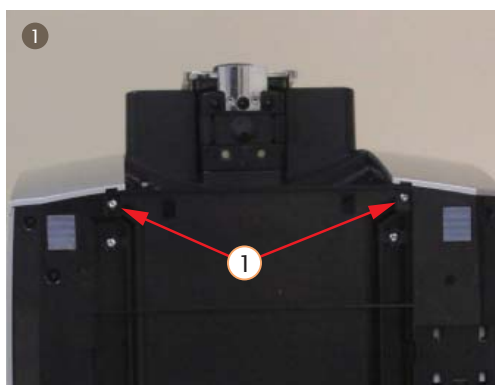

1. Disassemble the 2 screws from the bottom



2. Take out front cover right and front cover left separately according to the direction of the arrow

4.2.1.4 Disassemble right cover



1. Take out right side section according to the direction of the arrow

4.2.1.5 Disassemble coffee bean container group



1. Disassemble 4 screws from the coffee bean container, and take the coffee bean container out

4.2.1.6 Disassemble top cover



1. Disassemble 2 screws from the left side of the top cover

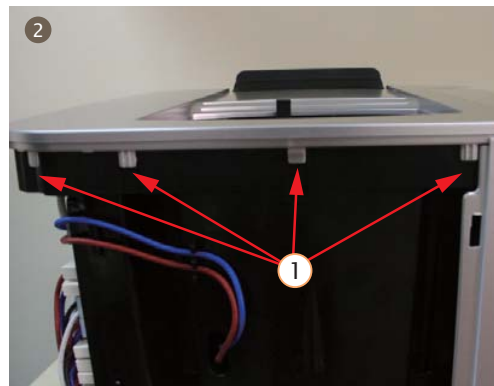

2. Loosen top cover and hook of the frame

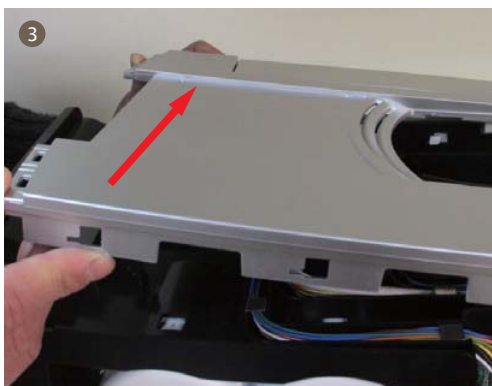

3. Take out top cover according to the direction of the arrow

4.2.1.7 Disassemble left cover



1. Disassemble left side section according to the direction of the arrow

4.2.2 Disassemble power cord

1. Refer to 4.2.1- Disassemble the exterior parts of the machine

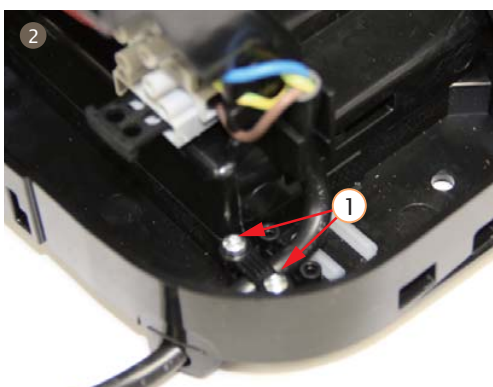

2. Disassemble 2 screws from the cable rack

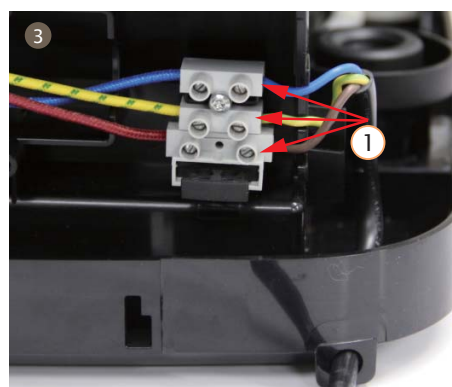

3. Disassemble 1 screw from support, loose 3 screws inside the line pencil connector and take out the power cord

4.2.3 Disassemble brew unit

1. Refer to 4.2.1- Disassemble exterior parts of the machine

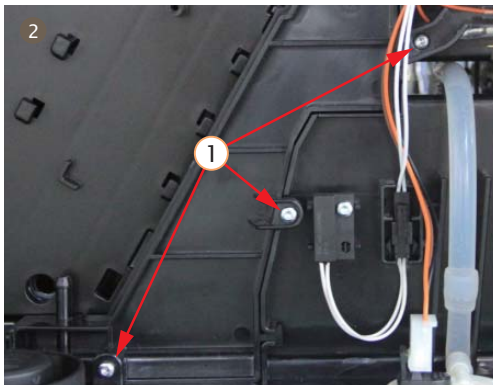

2. Disassemble 3 screws, and take out frame support

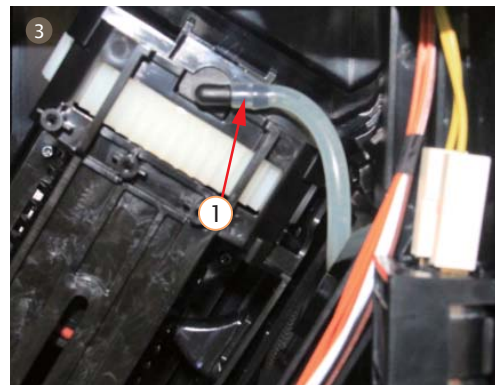

3. Pull out silicon pipe from brew unit

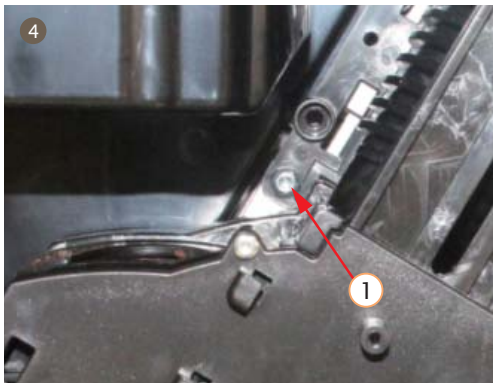

4. Disassemble 3 screws from brew unit

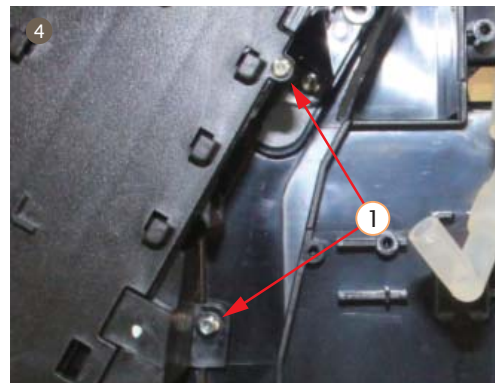

5. Pull the brewing unit outward and rotate the gear clockwise to the position as the picture shows

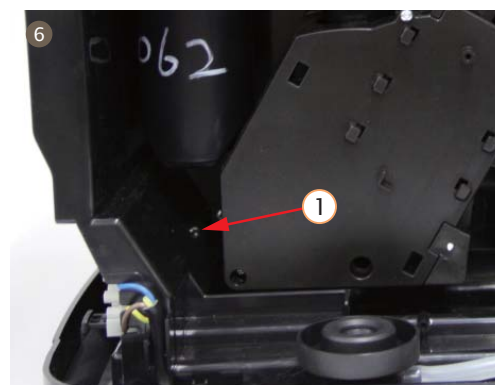

6. Disassemble 1 screw from backside and take out brew unit

4.2.4 Disassemble valve support group

1. Refer to 4.2.1-disassemble exterior parts

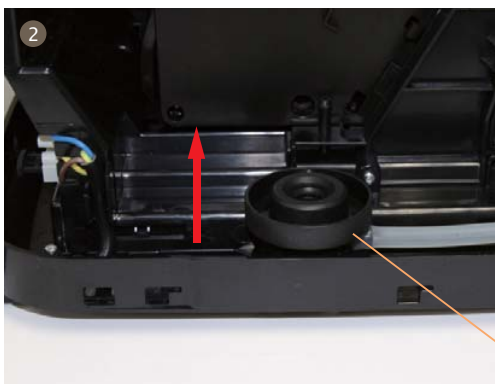

2. Take out valve support according to the direction of the arrow and pull out silicon pipe



Note: There are 4 hooks between valve support and base

4.2.5 Disassemble flowmeter

1. Refer to 4.2.1- Disassemble exterior parts

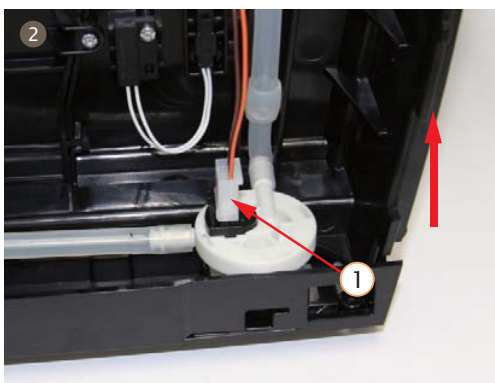

2. Pull out the flowmeter terminal, and pull out the flowmeter according to the arrow direction

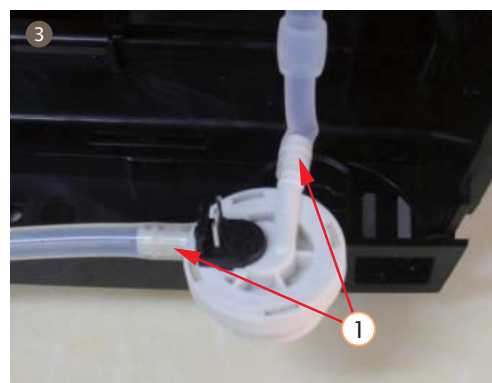

3. Pull out the silicone pipe at two sides of the flowmeter, and take out flowmeter

4.2.6 Disassemble solenoid valve group

1. Refer to 4.2.1-disassemble exterior parts



2. Disassemble hooks from support

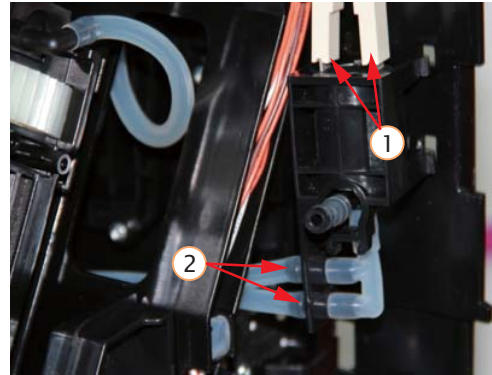

3. Pull out terminal and silicon pipe and take out solenoid valve group

4.2.7 Disassemble grinder group

1. Refer to 4.2.1.1-4.2.1.6-disassemble top cover

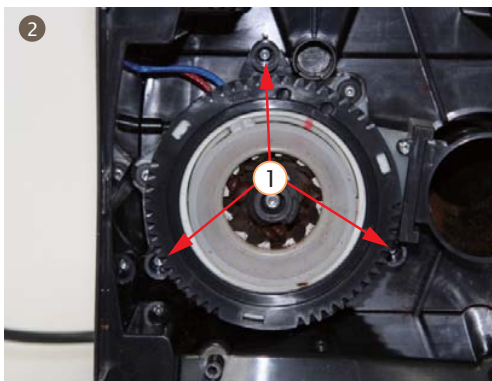

2. Disassemble 3 screws

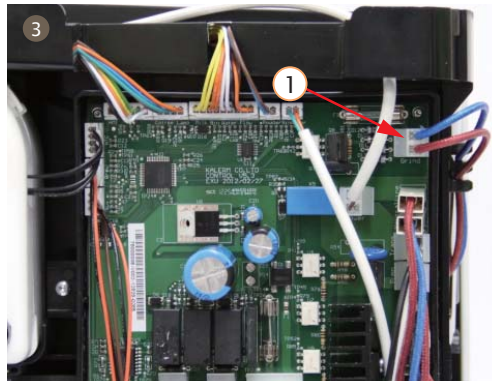

3. Pull out grinder motor terminal from PCBA and take out grinder group

4.2.8 Disassemble control panel group

1. Refer to 4.2.1-disassemble exterior parts

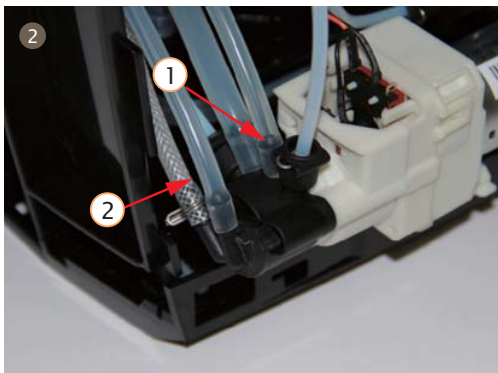

2. Pull out two silicon pipes from the dispenser valve on the right side of the machine

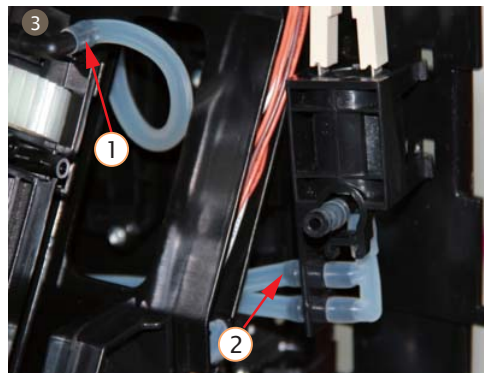

3. Pull out two silicon pipes from the left side of the machine

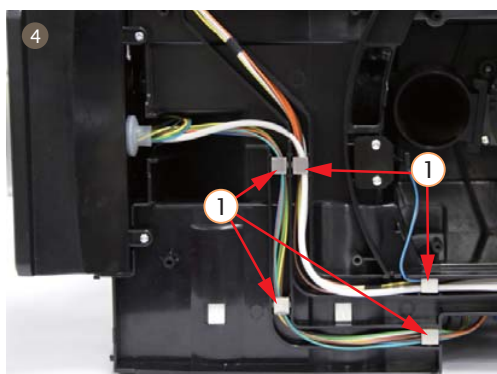

4. Disassemble 5 cable racks

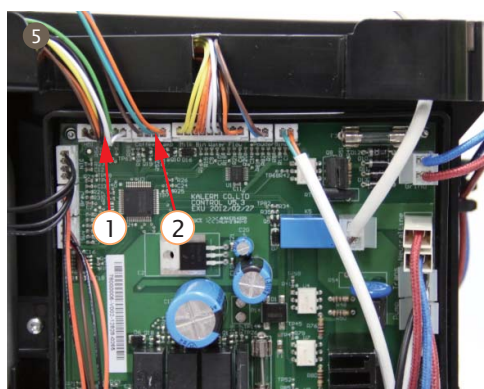

5. Pull out terminal on PCBA which connected to control panel

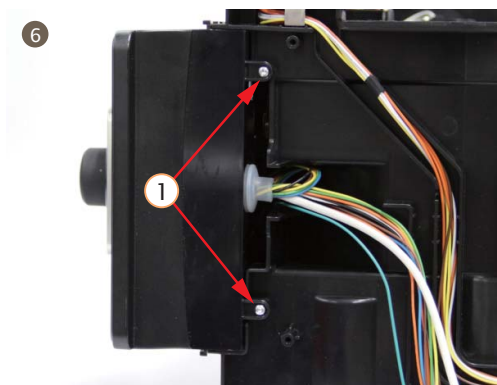

6. Disassemble 2 screws from the support

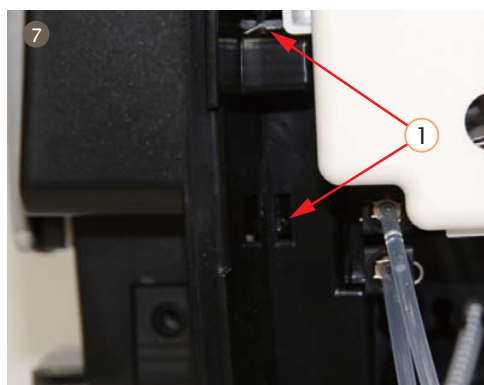

7. Disassemble left and right hooks on the support and take out control panel group

4.2.9 Disassemble dispenser valve group

1. Refer to 4.2.1.1-4.2.1.4-disassemble right side section

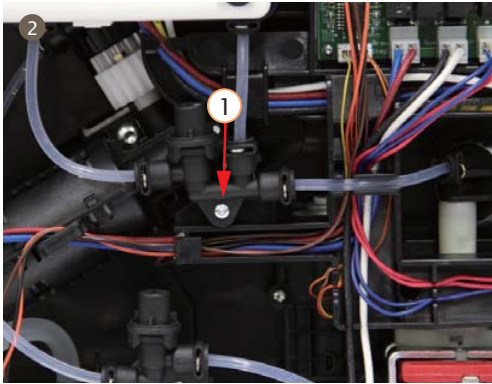

2. Disassemble 1 screw from dispenser valve 3W so that the wire can be taken out from the cable rack

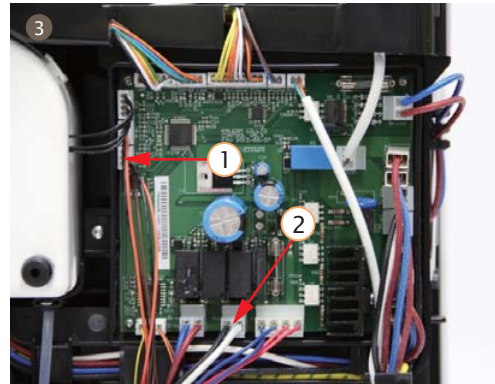

3. Pull out dispenser valve terminal on PCBA, and take it out from the cable rack

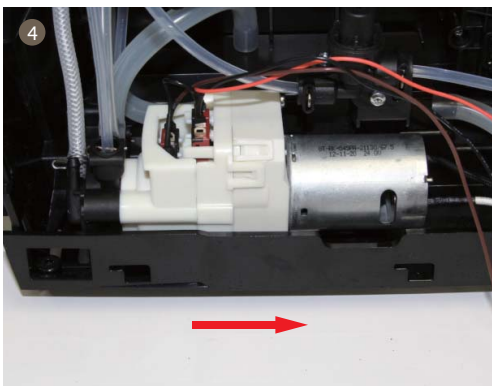

4. Move the dispenser valve group to the right side according to the direction of the arrow

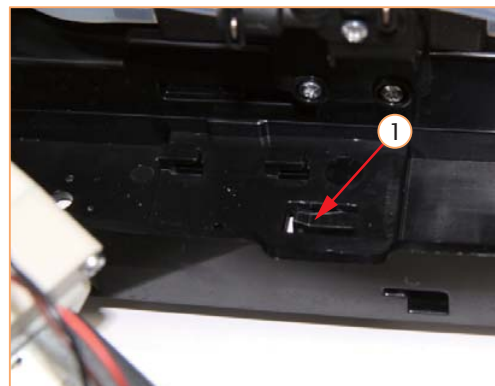

Note: There is one hook between the dispenser valve and base

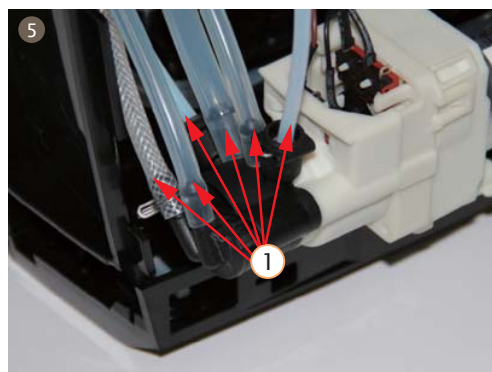

5. Pull out 5 pipes from dispenser valve, and take out dispenser valve group

4.2.10 Disassemble drainage valve group

1. Refer to 4.2.1-disassemble exterior parts
2. Refer to 4.2.3-disassemble brew unit group

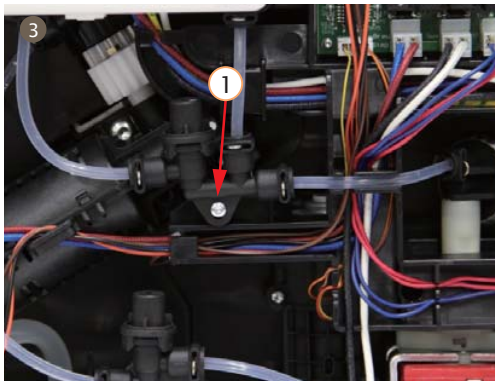

3. Disassemble 1 screw from dispenser valve 3W, so that the wire can be taken out from the cable rack

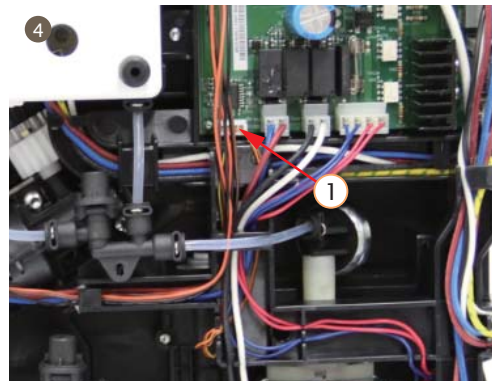

4. Pull out terminal from stepper motor on PCBA

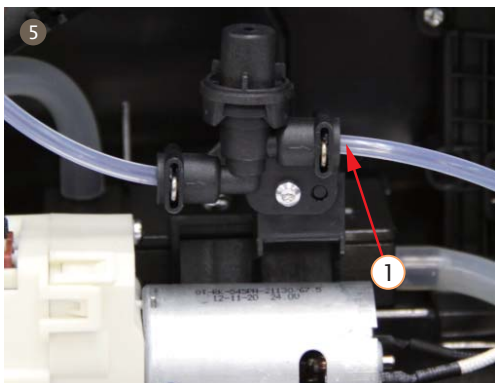

5. Pull out Teflon pipe between dispenser valve 2W and drainage valve

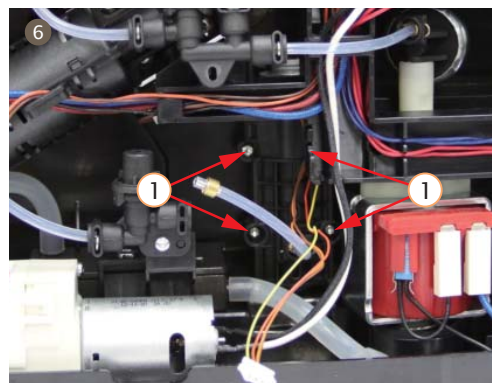

6. Disassemble 4 screws from support and take out drainage valve group



Note: There is a sealing element left at the bottom after taking out drainage valve group

4.2.11 Disassemble pump group

1. Refer to 4.2.1.1-4.2.1.4-disassemble right side section

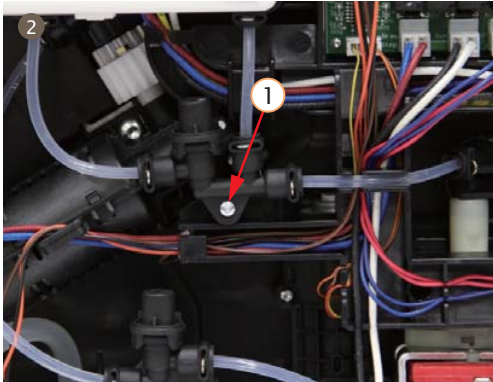

2. Disassemble 1 screw from dispenser valve 3W so that the wiring cable can be taken out from the cable rack.

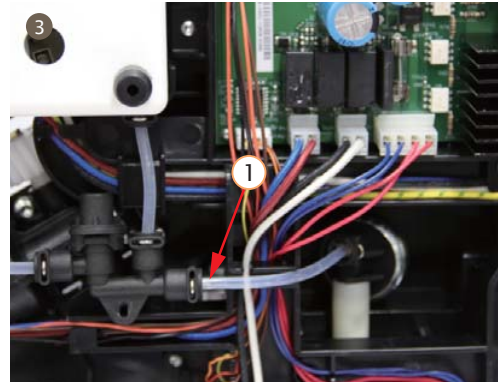

3. Pull out Teflon pipe on dispenser valve 3W that connected to pump

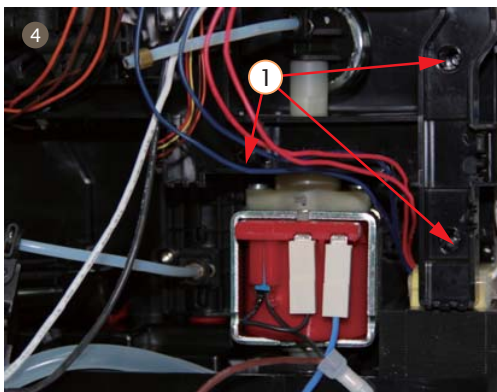

4. Take out all of line pencil from cable rack, disassemble 3 screws from cable rack and take out cable rack

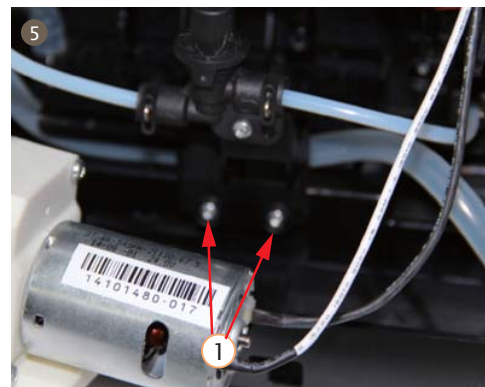

5. Pull out silicon pipe on condenser that connected to pump

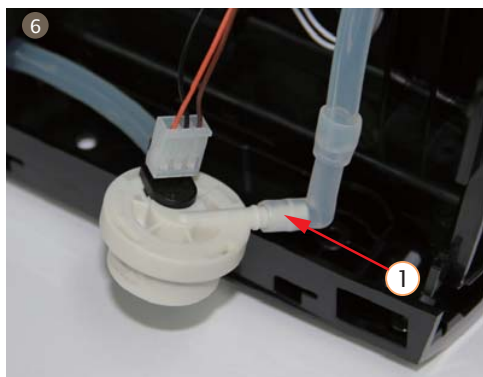

6. Pull out the flowmeter and pull out the silicone pip

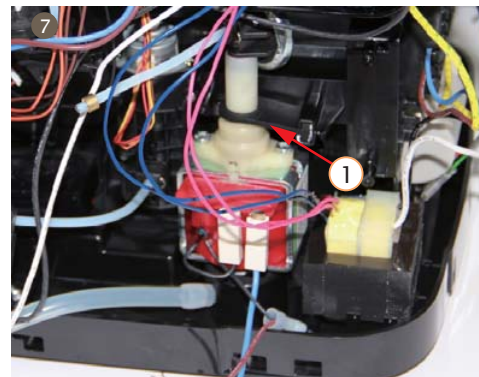

7. Pull out pump clamp from the support and take out pump group

4.2.12 Disassemble PCBA

1. Refer to 4.2.1.1-4.2.1.4-disassemble right side section



2. Pull out all the terminals on PCBA

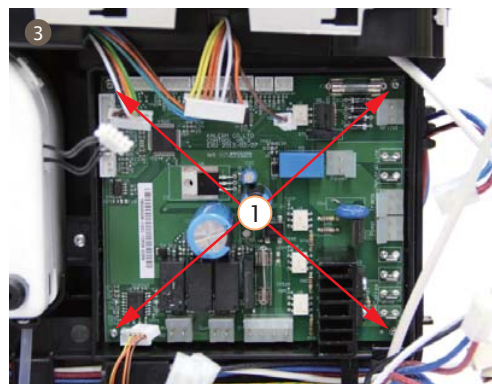

3. Disassemble 4 screws on PCBA, and take out PCBA

4.2.13 Disassemble dispenser valve 2W

1. Refer to 4.2.1.1-4.2.1.4-disassemble right side section

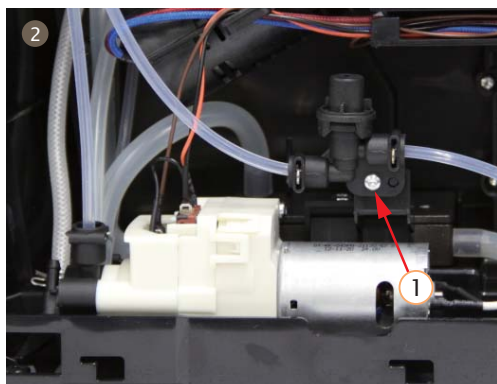

2. Disassemble 1 screw

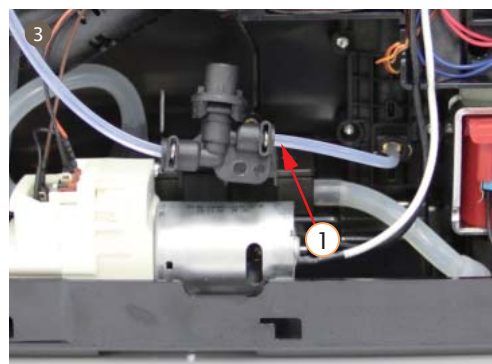

3. Pull out Teflon pipe on dispenser valve 2W that connected to pump, and take out dispenser valve 2W

4.2.14 Disassemble dispenser valve 3W group

1. Refer to 4.2.1.1-4.2.1.4-disassemble right side section

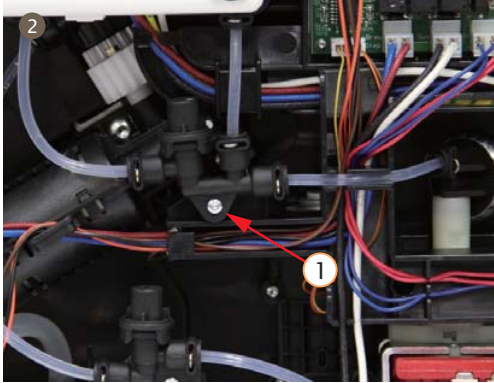

2. Disassemble 1 screw from dispenser valve 3W

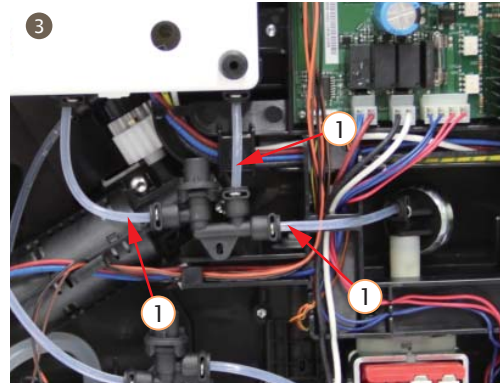

3. Pull out 3 Teflon pipes which connected to dispenser valve 3W, and take out dispenser valve 3W

4.2.15 Disassemble thermoblock group

1. Disassemble top cover according to 4.2.1.1-4.2.1.6

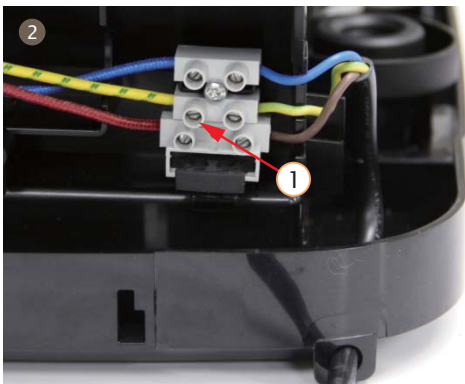

2. Loose screw on the line pencil connector

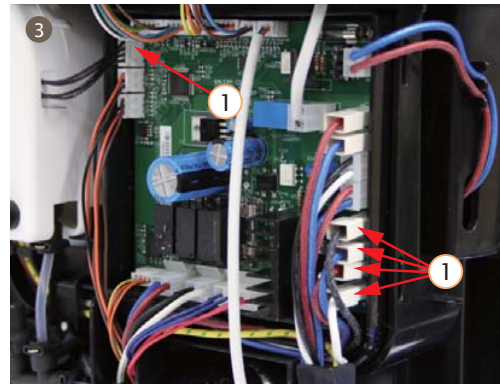

3. Loose the screw near the ground wire on the line pencil connector

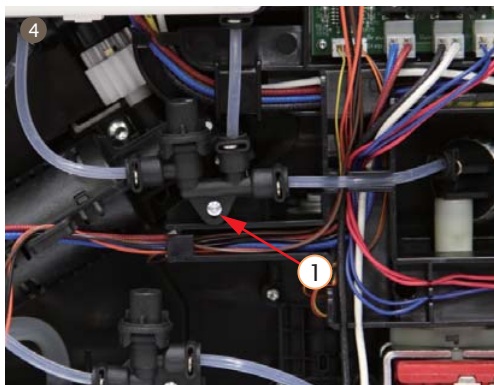

4. Disassemble 1 screw from dispenser valve 3W

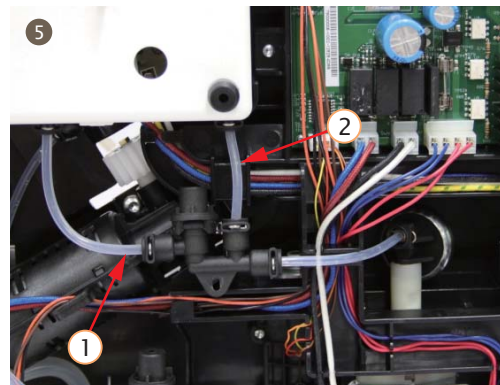

5. Pull out Teflon pipe which connected thermoblock group and dispenser valve 3W and dispenser valve 2W

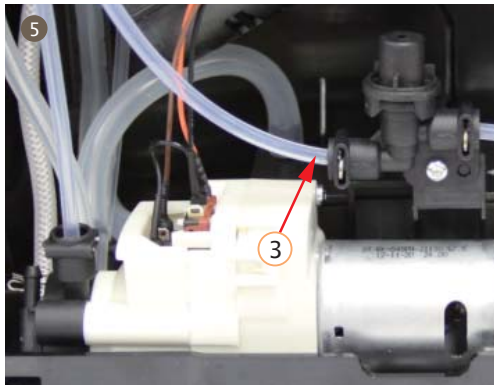

5. Move dispenser valve group, and pull out Teflon pipe which connected thermoblock

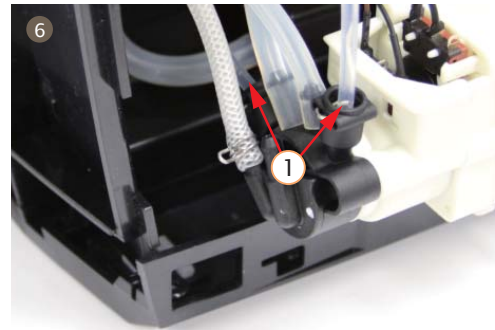

6. Move dispenser valve group, and pull out Teflon pipe which connected thermoblock

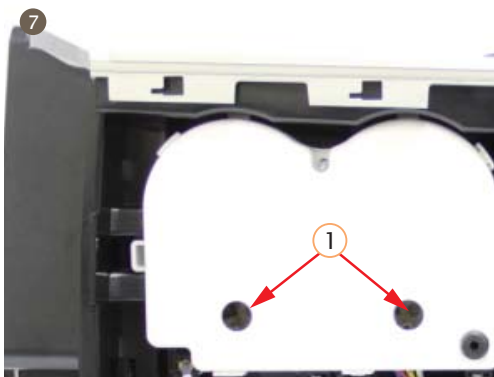

7. Disassemble hooks from support, and take out thermoblock group

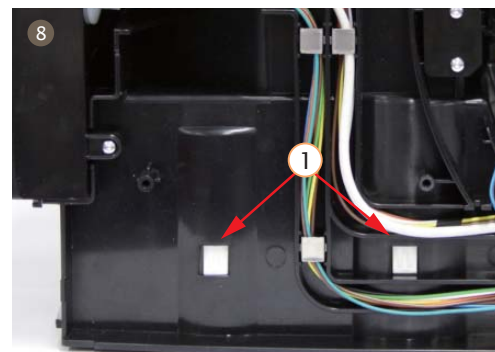

8. Disassemble hooks from the support and take out thermoblock

4.2.16 Disassemble ground coffee container lid switch group

1. Refer to 4.2.1.1-4.2.1.4-disassemble top cover

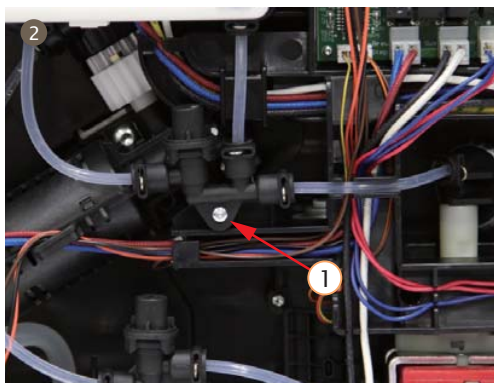

2. Disassemble 1 screw from dispenser valve 3W so that the wiring can be taken out from the cable rack

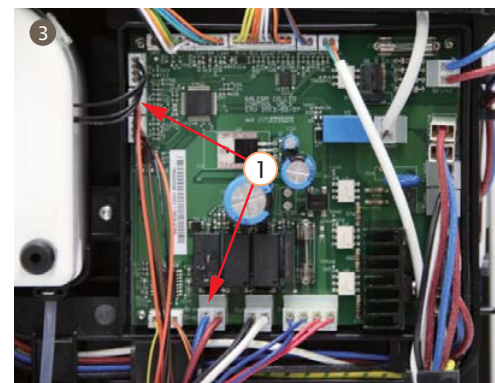

3. Pull out motor group terminal from PCBA and separate with cable rack

Repair

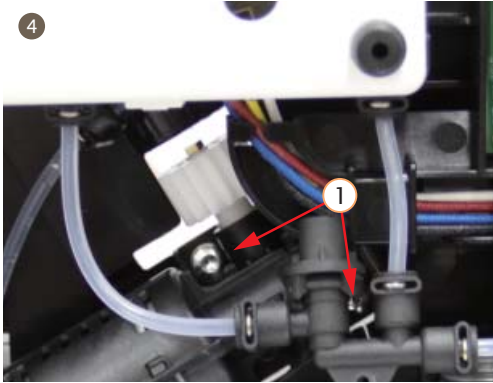

4. Disassemble 2 screws from support and take out geared motor group

4.3 Precautions for maintenance and installation

4.3.1 Brew unit group



1. Disassemble the spool gear group according to the arrow direction

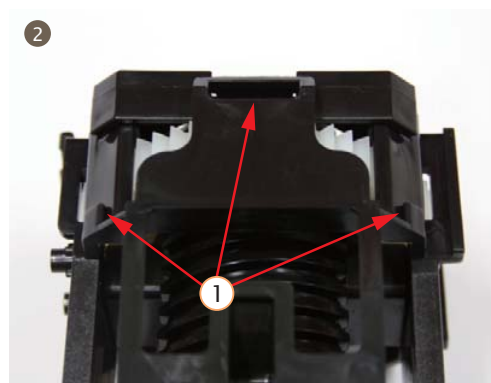

2. Disassemble the wiper, notice the hooks showed by the arrow

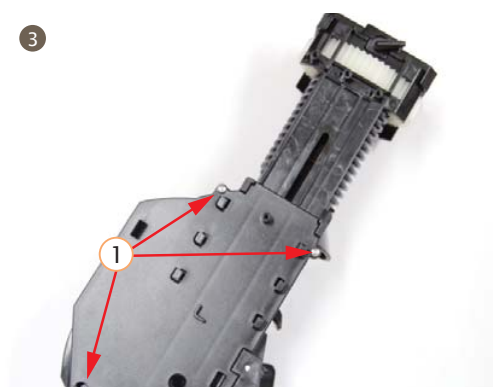

3. Disassemble the 4 screws from the left and right cover

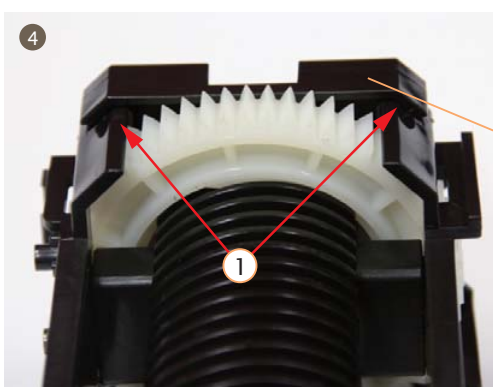
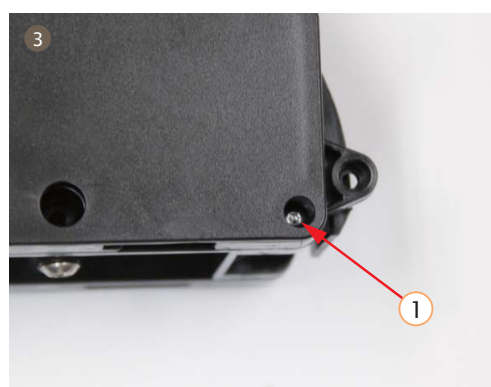

4. Disassemble 4 hooks from the top cover of the brew unit, take out top cover of brew unit

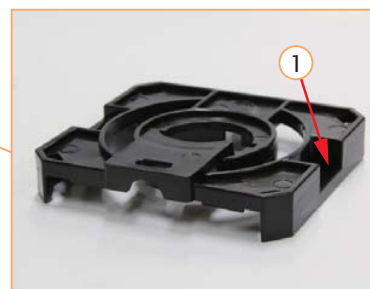

Note: deeper slot side should be installed to the front position of the brew unit. It should match the wiper

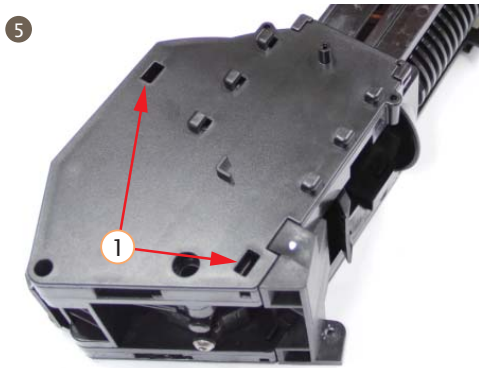

5. Disassemble five hooks at the back of the left and right cover, and take out the left and right cover

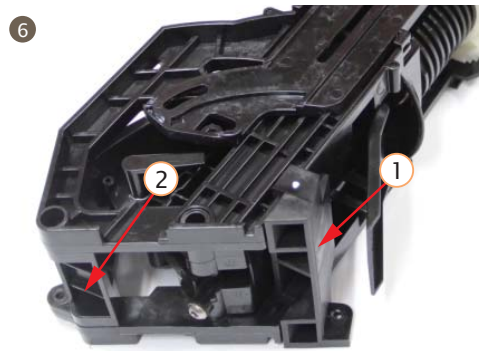

6. Take out connect part and reset base



7. Take out left and right pull plate and pull plate sleeve



8. Rotate the gear

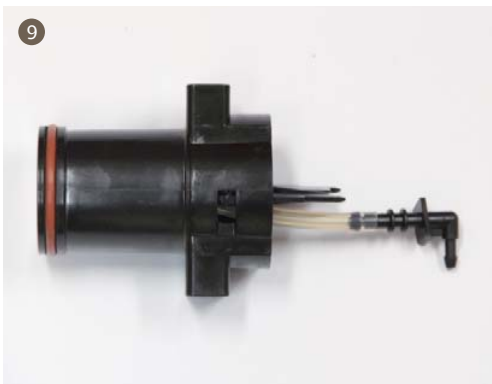

9. Take out the contropistone



10. Take out the connector, pay attention to the direction of the spring.

11

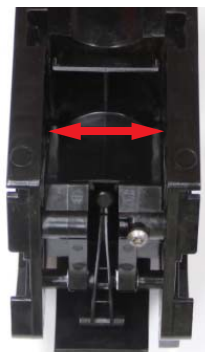

11. Deform brew unit frame with strength according to the arrow direction, and take out coffee brewing group

12

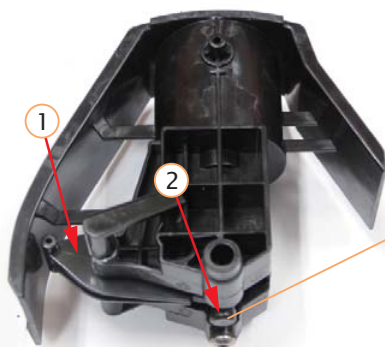

12. Disassemble release link, and take out piston

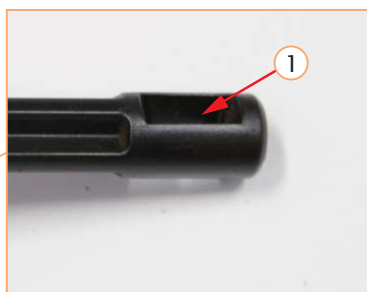

Note: The bigger opening of the piston should face to the release link.

13

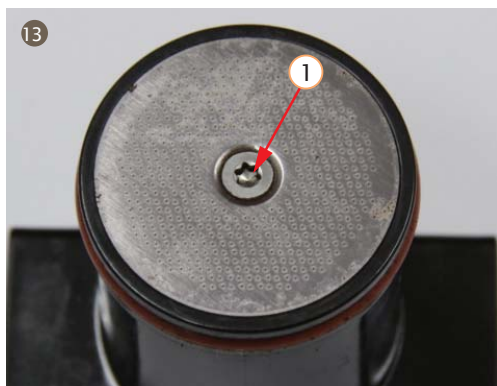

13. Disassemble the screw from contropistone, and take out filter screen

14

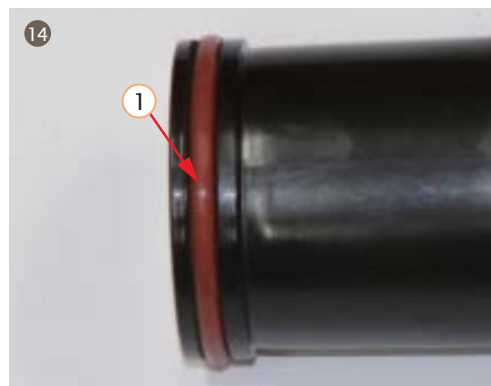

14. Disassemble seal from contropistone

4.3.2 Dispenser valve 6W

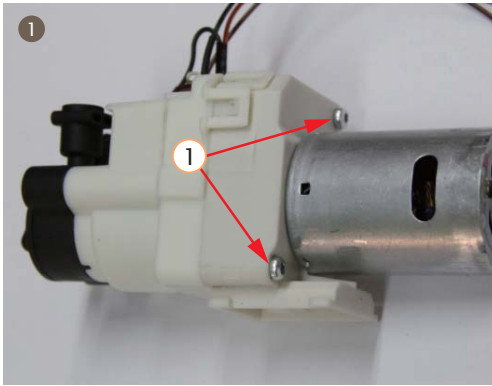

1. Take out 2 screws from dispenser valve

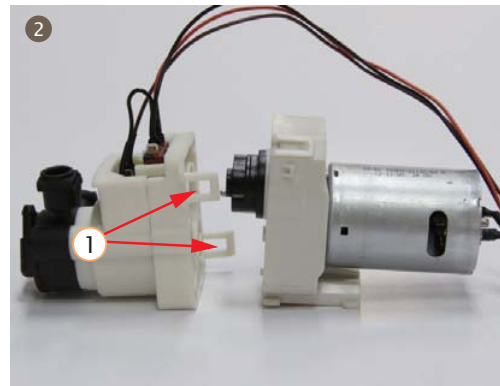

2. Loose the hook, and separate gear box for dispenser valve from the water dispenser box



3. Disassemble the 2 screws from the dispenser valve



4. Take out water distributor and get out ceramic plate sheet gasket





5. Take out the top cover of the dispenser valve

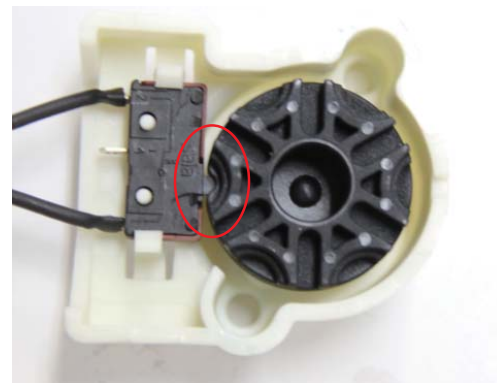
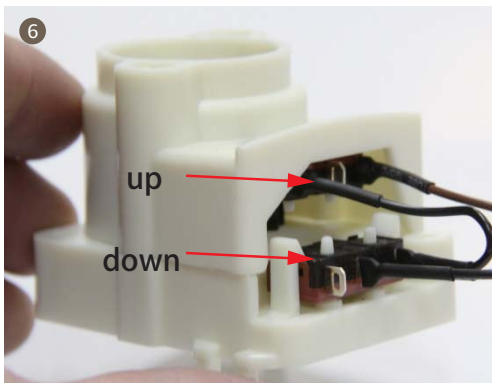

6. Separate dispenser valve from sheave permanent seat, take out sheave and disassemble microswitch.



Note: when installing, the microswitch with two lines should be in the upside and the microswitch with three lines should be in the downside; the black side of the upside microswitch should face down, the black side of the downside microswitch should face up. The slot on the sheave should face to the connector of the microswitch.

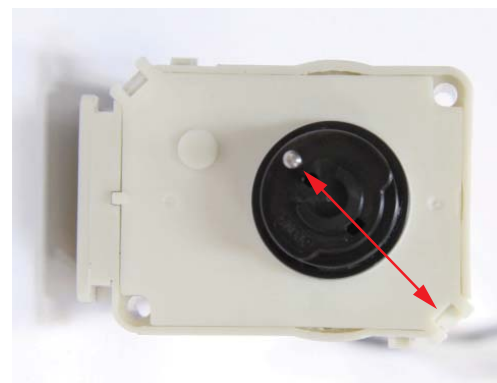

7. Take out the sheave and disassemble the microswitch



Note: Take out the sheave drive part according to the arrow direction

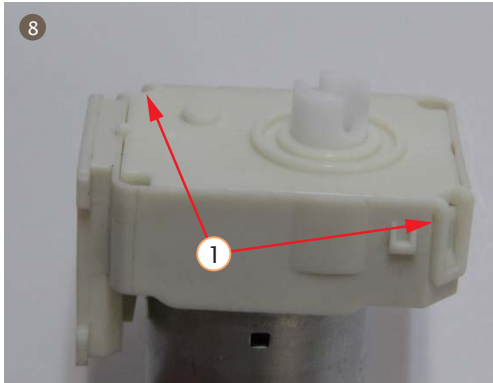

8. Disassemble the hook on gear box lid, and take out gear box lid

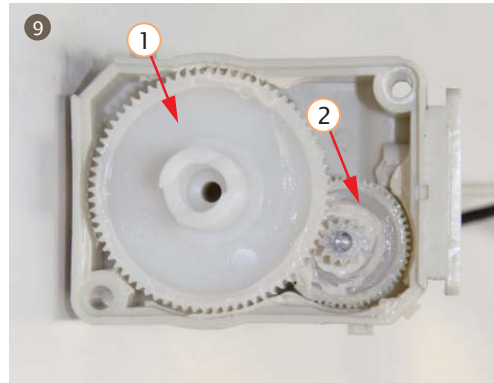

9. Take out dispenser valve gear A and dispenser valve gear B

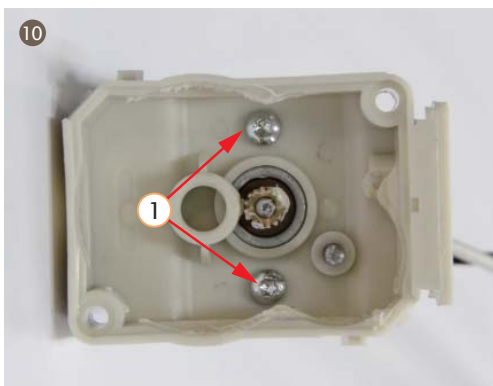

10. Disassemble 2 screws inside the gear box, and take out the motor for dispenser valve

4.3.3 Grinder group



1. Disassemble the 3 hooks from the grinder adjustment sector and take out the grinder adjustment sector

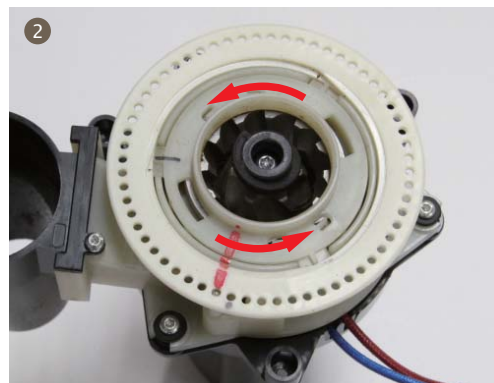

2. Rotate the upper burr group anticlockwise

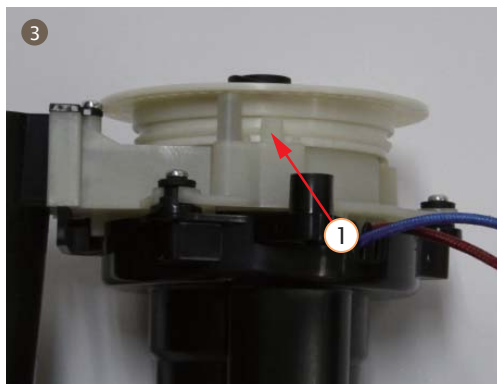

3. Disassemble the three hooks from the motor support for grinder, and take out the grinder adjustment ring

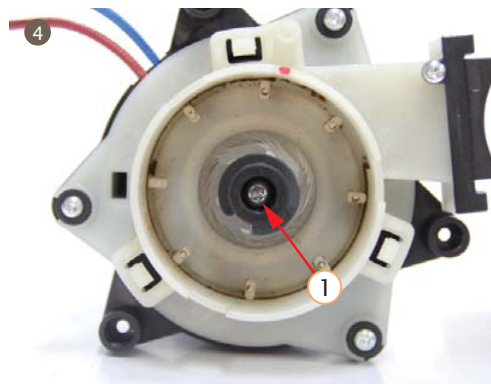

4. Disassemble 1 middle screw

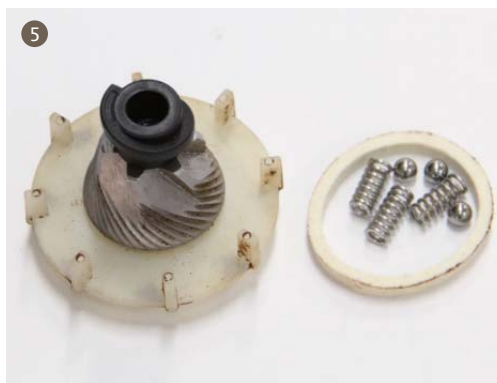

5. Take out the line pencil and conical burr group

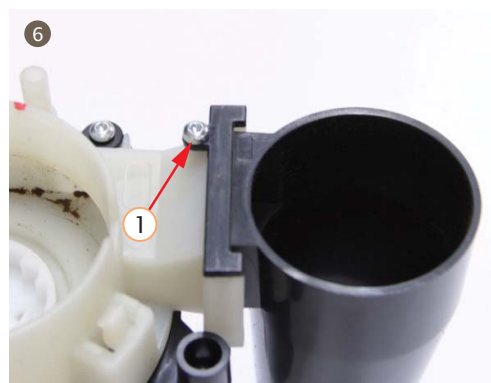

6. Take out 1 screw from the coffee powder hopper

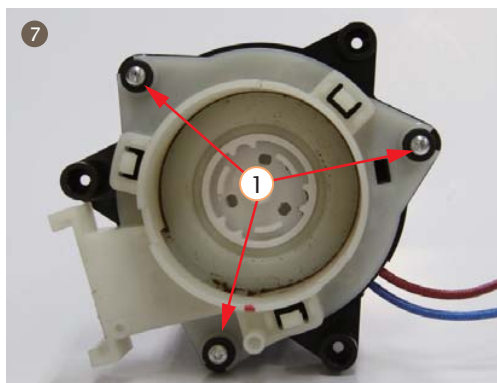

7. Disassemble 3 screws from grinder support, and take out grinder support

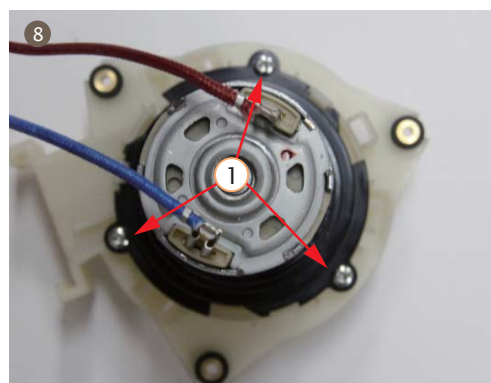

8. Take out 3 screws from the gear box

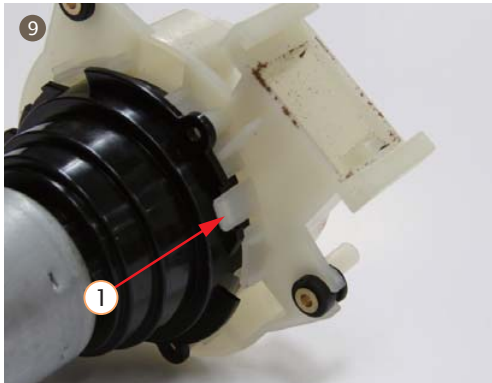

9. Take out the 3 hooks from the gearbox, and then take out the coffee powder container



10. Disassemble steel ball support and 34 pcs steel ball



11. Take out the epicyclic gear group B



12. Take out filler piece and the epicyclic gear group A

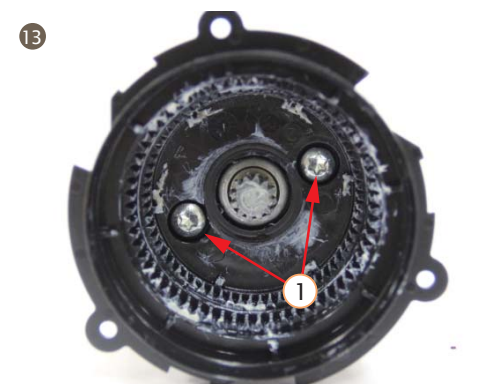

13. Disassemble the 2 screws inside the gearbox, and take out the grinder motor

4.3.4 Control panel group



1. Take out foam rubber group



2. Pull out the rotary according to the arrow direction

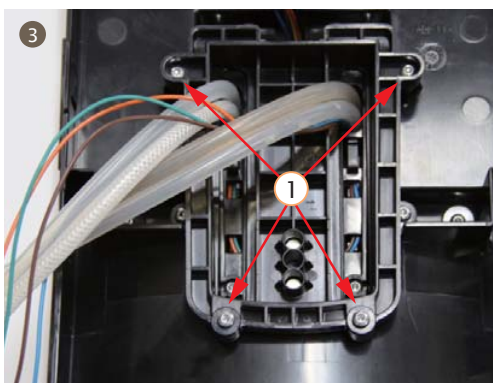

3. Disassemble 4 screws from the backside of control panel

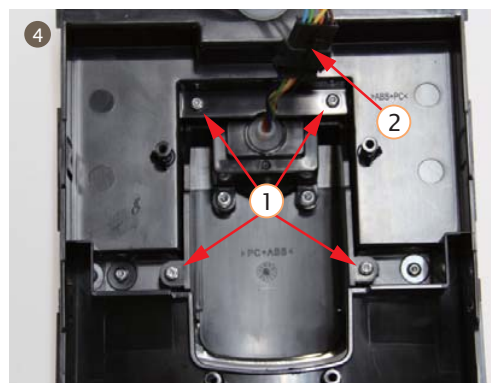

4. Pull out 4 screws from the backside of the control panel, and pull out the terminal, then take out the decorative plate group

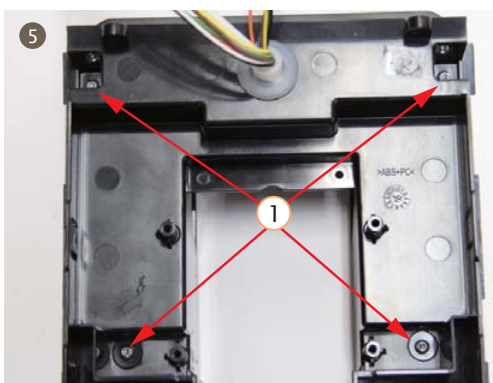

5. Pull out 4 screws from the backside of the control panel, and pull out the terminal, then take out the decorative plate group

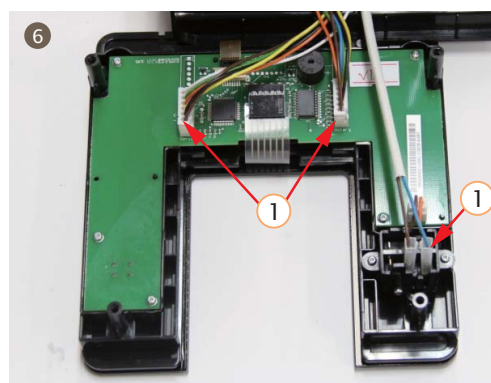

6. Pull out 2 terminals on HMI and the terminal on the power switch and take out the touch screen group

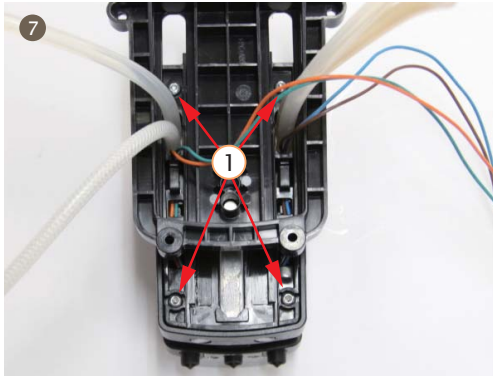

7. Disassemble 4 screws from the export group, and take out the sliding group

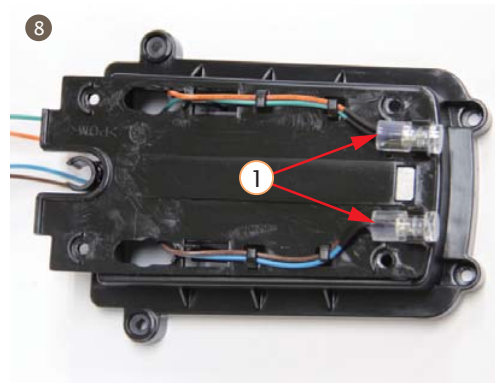

8. Take out the LED

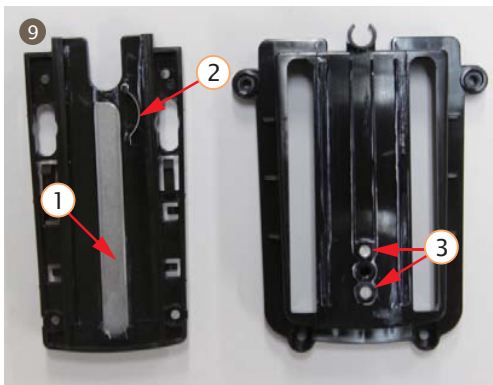

9. Separate coffee export sliding panel and coffee export support, and take out magnet sliding panel and shell fragment magnet



10. Disassemble 1 screw inside the coffee export base, and take out the coffee export group

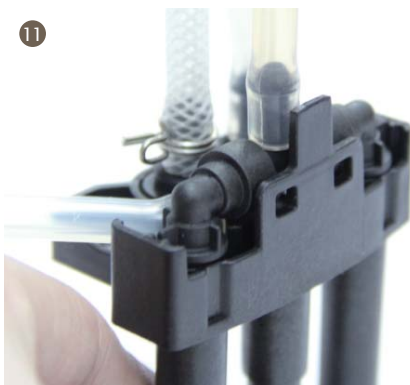

11. Pull out all the silicon pipes



12. Disassemble the connector and seal



13. Disassemble 2 screws from the handle, and take out the handle



14. Disassemble 2 screws from the backside of the touch screen decorative cover; take out decorative plate and smokebell

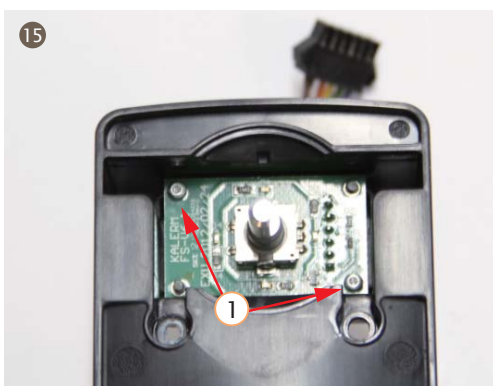

15. Disassemble 2 screws from the rotary, and take out the bottom terminal, and then take out the rotary PCB

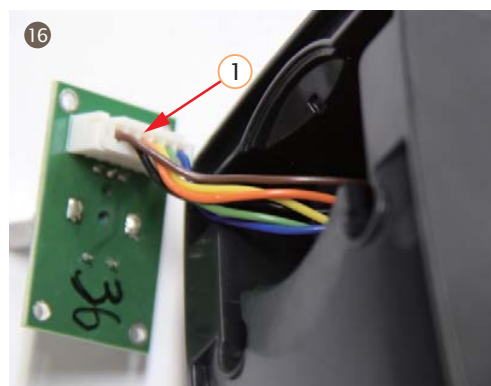

16. Take out terminal from the bottom of rotary PCB, and take out the rotary PCB

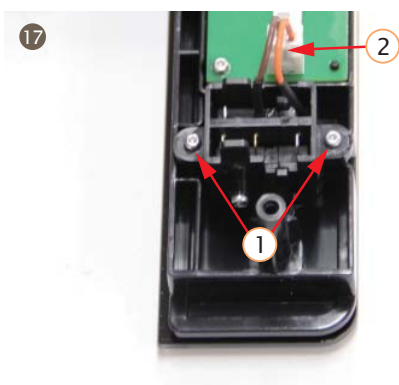

17. Take out 2 screws from the switch support, pull out the terminal from the HMI, and take out the switch group



18. Take out the spring and the power button, and disassemble power button decorative cover

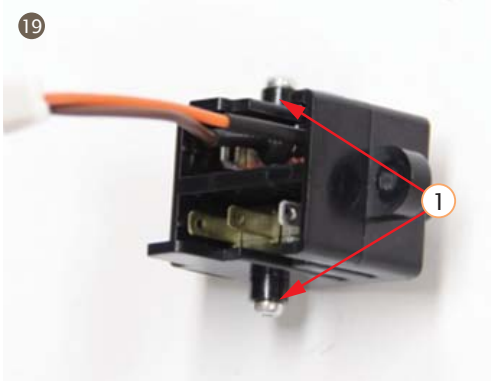

19. Disassemble the 2 screws at both sides of the switch support, and then take out 2 microswitch

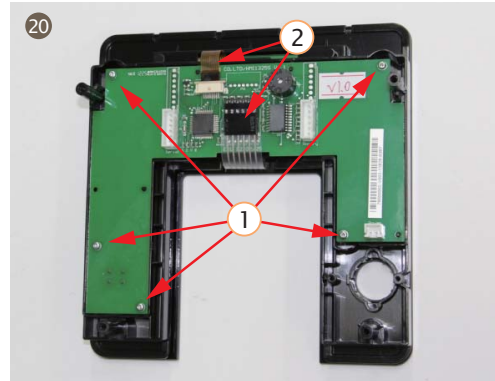

20. Disassemble 5 screws from the HMI, pull out two terminals, and take out HMI



21. Take out silica gel, clean buttons and smokebell, and clean the power button decorative cover



22. Take out touch screen



23. Disassemble 2 screws from display screen, and take out the OLED screen

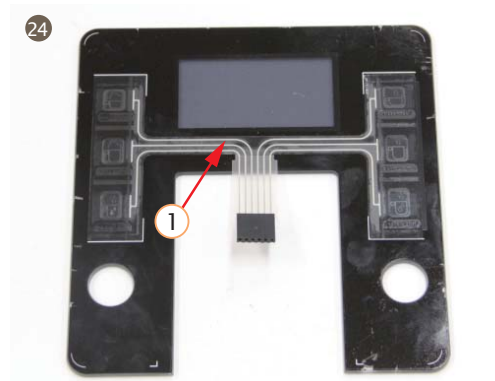

24. Take out ITO which stuck to touch screen



Precautions for assembling

Drainage valve group



1. Assemble the drain valve support, pin, pin sleeve, pin reset spring, pin seal together as the picture shows. Pay attention to the direction of the pin seal.



2. Assemble the drainage export and pin seal together.



3. Assemble the pin seal, pin and drainage valve pipe into the drainage valve. Pay attention to the direction of the pin seal as the picture shows.

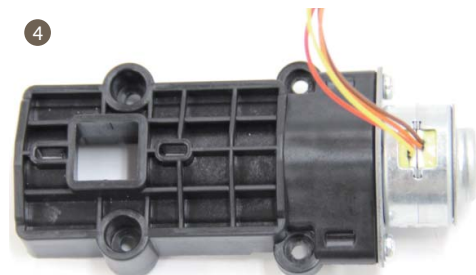

4. Put the stepper motor and drainage valve support lock together. Pay attention to the direction of the stepper motor.



5. Assemble them into drainage valve, and install the seal, Teflon pipe and clamps.

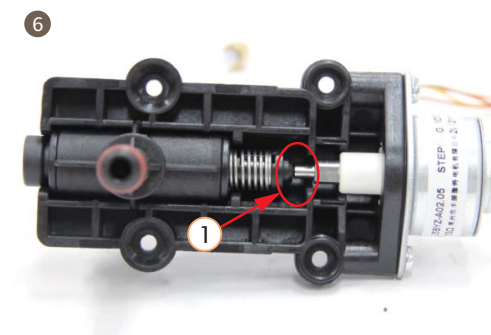

6. Rotate the tail of the stepper motor to make the axis of the stepper motor stand up to the drain valve support until it cannot stand up any more.

Dispenser valve group

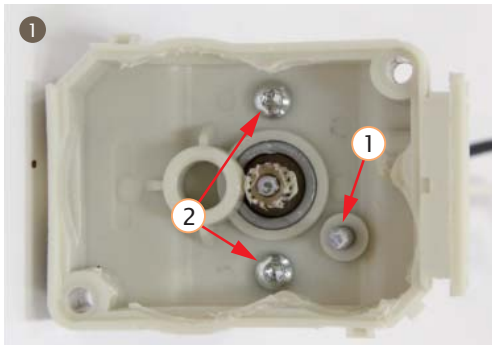

1. Press the gear pin into the hole of the gearbox, and put the dispenser valve motor to gearbox. The screws need a few loctite.



2. Install dispenser valve gear A and dispenser valve gear B into dispenser valve gearbox after coat oil(MI-setral-61B).



3. Install the gear box lid and sheave drive part, pay attention to the position of the sheave drive part.

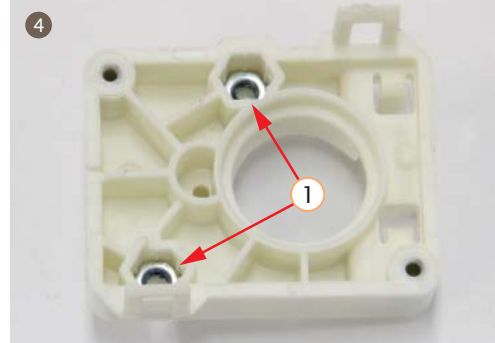

4. Install 2 screws inside the sheave permanent seat.

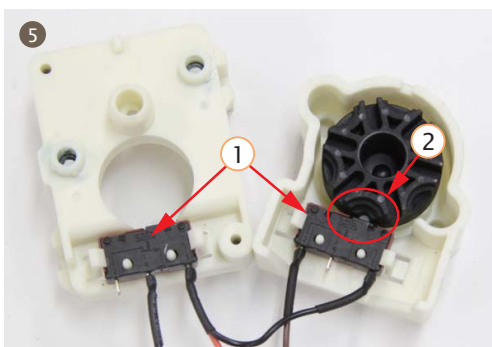

5. Install microswitch line pencil switches to sheave permanent seat and dispenser valve separately. Pay attention to the position and the direction of the sheave and microswitch.

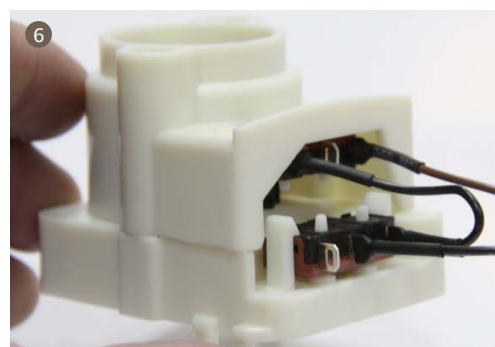

6. Assemble the sheave permanent seat and dispenser valve together.

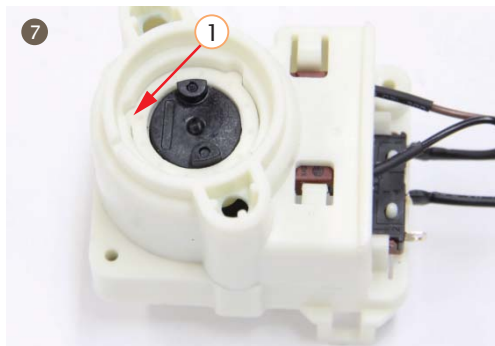

7. Install the ceramic plate A into the dispenser valve. The upper side should be the side of slot, and it should be covered with oil(SYN-setral-AI/C 2-FD).

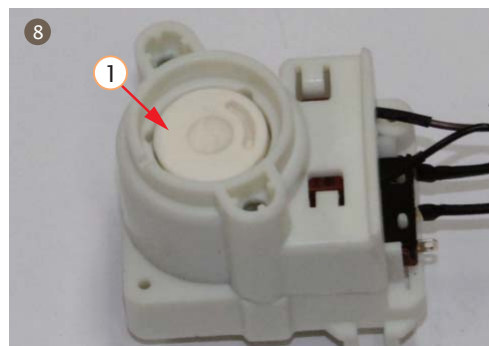

8. Install the ceramic plate B into the dispenser valve. Both sides should be covered with oil((SYN-setral-AI/C 2-FD).



9. Install the seal on the dispenser valve top cover.



10. Assemble dispenser valve top cover and water distributor together.



11. Put the dispenser valve silicon plate into the slot of the water distributor.



12. Assemble the ceramic plate C on dispenser valve silicon plate, the smooth side should be covered with oil(SYN-setral-AI/C 2-FD).

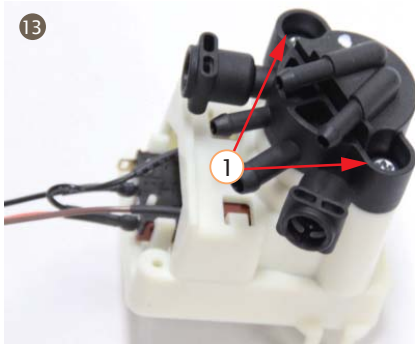

13. Assemble the water distributor to the dispenser valve, and lock the screws on both sides uniformly, the head of the screws need loctite.

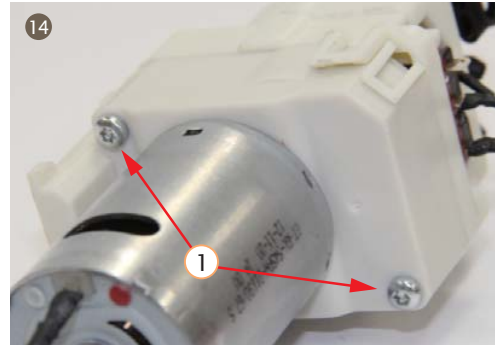

14. Assemble the water dispenser box and the gear box together, and then lock the screw.

Valve support group



1. When installing the support seal, the downside should be with bigger diameter.

Brew unit

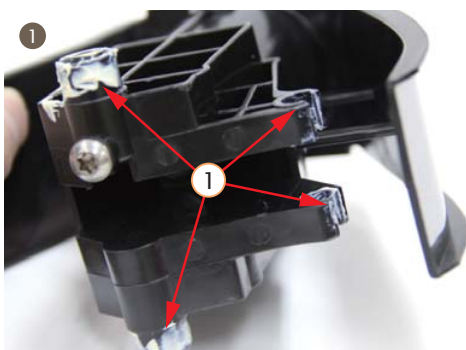

1. Install the piston and release link into the coffee brewing unit, oil(MI-setral-61B) coating position should be as the picture shows.





2. Install the coffee brewing unit into the brew unit frame, and install reset base and connect part.



3. Assemble the pin seal and pin together to drainage valve connection. Note: the direction of the pin seal.



4. Coating the contropistone seal with lubricating oil(SYN-setral-AI/C 2-FD) and install to the contropistone, and then lock the filter screen.



5. Assemble the connector, ball and spring into contropistone. Pay attention to the arrow direction.



6. Assemble the already installed contropistone into the brew unit frame. Note: The direction of the contropistone should be the same as the picture showed.



7. Rotate the gear onto the brew unit frame, install the sleeve pipe, the small head of sleeve pipe should be inward.

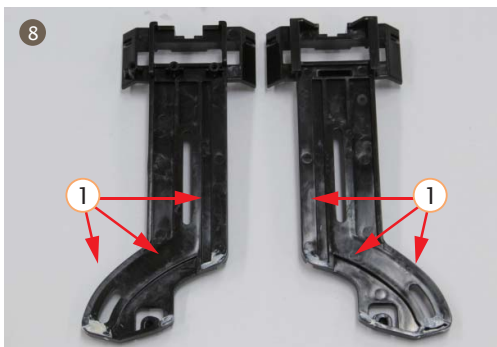

8. Install the left and right pull plate and left and right cover on brew unit frame, oil (MI-setral-61B) coating position for left and right pull plate should be as the picture shows.

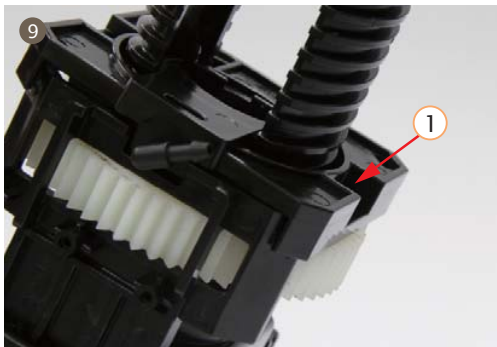

9. Install the brew unit top cover.



Note: Pay attention to the direction of the brew unit top cover, the deeper groove should be in front.

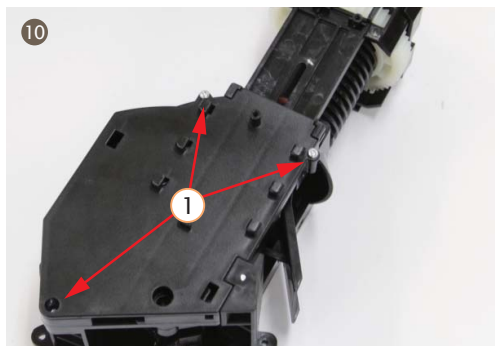

10. Lock the left side and right side cover screws.



11. Install wiper and spool gear group.

Control panel group



1. When installing microswitch and power microswitch support, please pay attention to the connection position between microswitch and connector.



2. When installing silicon pipe, please note the position of every silicon pipe inside the hole of the coffee export.

Thermoblock



1. When install the NTC on the thermoblock, cover NTC with silicone grease and fasten it.

Grinder group

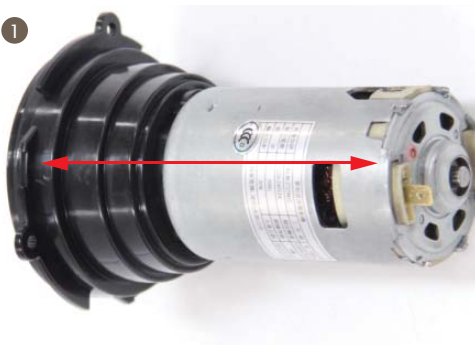

1. Assemble the grinder motor and gearbox together, and screw them tightly. The screw should be covered with loctite. The teeth of the gearbox should be coated with oil(MI-setral-61B). The red mark place should correspond to one hole of the gearbox.



2. Install 3 epicyclic gear A and 3 epicyclic gear pin A into epicyclic gear support A, and coat with oil(MI-setral-61B).



3. Install 3 epicyclic gear B and 3 epicyclic gear pin A into epicyclic gear support B, and coat with oil(MI-setral-61B).



4. Put the already installed epicyclic gear frame A into the gearbox, put 1 filler piece onto epicyclic gear frame A.



5. Put the already installed epicyclic gear frame B into gearbox.



6. Put the steel ball support and 34 roll steel ball into gearbox.



7. Install 3 grinder antivibration pads and 3 antivibration bushes into coffee powder container.



Note: The installation direction for the grinder antivibration pads and 3 antivibration bushes.

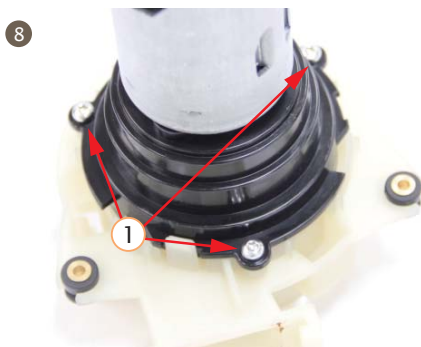

8. Install the coffee powder container into the gearbox, the bigger hook on the coffee powder container should compare to the bigger groove. Screw tightly.

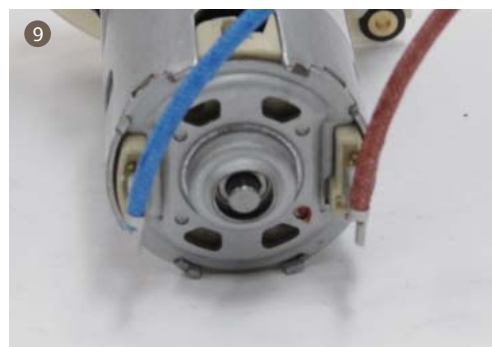

9. Install the line pencil into the grinder motor, red line correspond to the red mark.

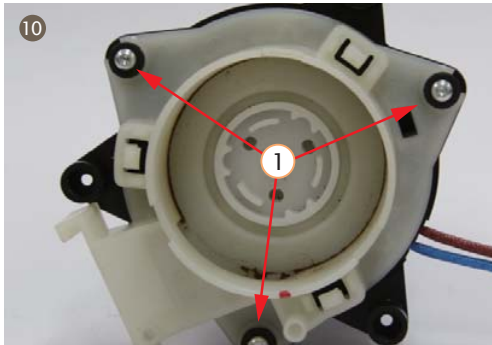

10. Insert the already installed grinder motor in the grinder support, and lock screws.

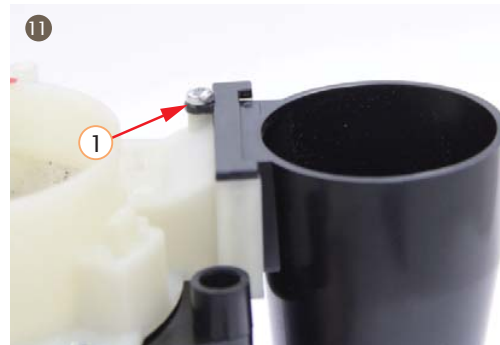

11. Install the coffee powder hopper on the coffee powder container, and lock the screw.



12. Install 3 spring sleeves into the hole of the support lower grinder.



13. Install the screw pin worm drive and conical burr to support lower grinder.



14. Put 3 conical burr protective steel balls and spring into support lower grinder.

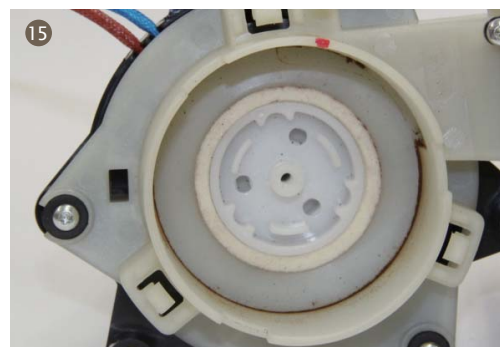

15. Put the felt ring into the already installed coffee powder container.

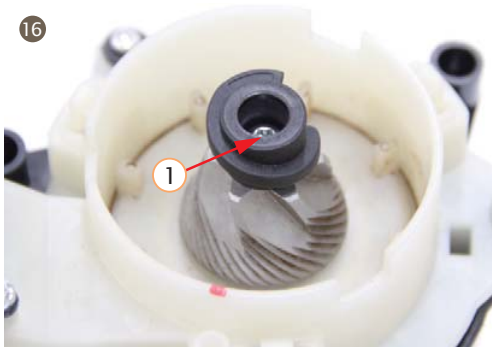

16. Put the already installed support lower grinder into the coffee powder container and lock the screw.

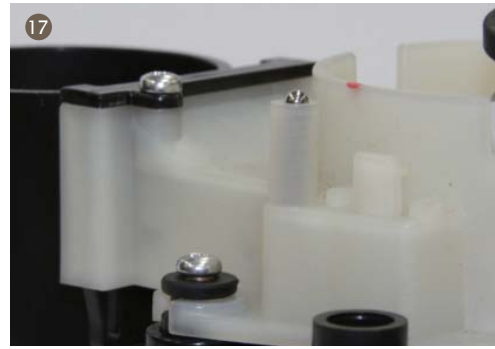

17. Install the grinding adjustment spring and steel ball into the coffee powder container pillar.



18. Install the grinder adjustment ring in the motor support for grinder.



19. Assemble upper burr, upper grinder support, upper grinder cover and support seal together.



20. Insert the already installed upper burr into motor support for grinder, and adjust the gap between the conical burr and upper burr.



21. Install the grinder adjustment sensor to grinder adjustment ring. The position should be as the picture shows.

22. The already installed grinder group should be tested when the whole machine is installed. The thickness of the powder should be adjusted properly.

5. Function test and maintenance methods

5.1 Function test and test standards

Test	Temperature	Volume	Time
espresso	75-83°C	40-60ml	10-15s
long coffee	75-85°C	80-110ml	23-30s
cappuccino	---	---	---
latte	---	---	---
hot water	High: 80-90°C	High: 90-110ml	---
	Normal: 70-80°C	Normal: 90-110ml	
	Low: 60-70°C	Low: 90-110ml	
hot milk	41-50°C	75-110ml	15s
hot cream	50-58°C	60-90ml	15s

5.2 Coffee machine maintenance

5.2.1 Coffee machine decalcifying

Use Kalerm decalcifier only. It may damage machine if use other decalcifier.
The whole process costs about 25 minutes.



1. Empty tray
2. Dissolve decalcifier in the clean water, and pour into the water tank- the water inside the water tank should be half of the water tank.



3. Press rotary for 3 seconds to enter in the program menu, rotate the rotary to MAINTAINCE.

4. Enter in DECALCIFYING program and operation as the screen displays (put a container which is over than 1L under the coffee export) .

5. After the first cleaning, take out water tank and pour the rest water and clean water tank. Add fresh pure water again and install the water tank.

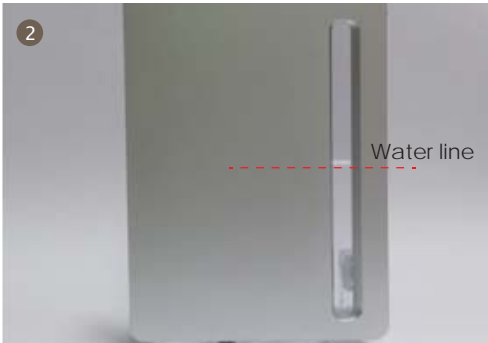

6. After the second cleaning, coffee machine starts preheating.

7. After preheating, the third cleaning starts.

8. The screen shows READY , decalcifying finishes. Coffee can be made now.



Daily descale comparison table

Water hardless level	Descale cycle
●●●●●	around 2-4 weeks
●●●●○	around 4-6 weeks
●●○○○	around once per 2 months
●○○○○	around once per 3 months

5.2.2 Rinse the brew unit

cleaning agent

Use Kalerm cleaning agent only. It may damage machine if use other cleaning agent.
The whole process costs about 10 minutes.



1. When machine in READY state, press rotary for 3 seconds to enter in the program menu, rotate the rotary to MAINTAINCE.

2. Press the rotary to enter the coffee machine maintenance menu, jog shuttle dial to " clean brew unit " page.

3. Press the rinse button to confirm wash into " clean brew unit " .

4. Follow screen prompts to clean brew unit, cleaning brew unit process, it needs to open the power cover, add cleaning tablets.

5. After cleaning, coffee machine enter the Ready state.

5.2.3 Rinse milk unit

The whole process costs about 2 minutes.



1. When machine in READY state, press rotary for 3 seconds to enter in the program menu, rotate the rotary to MAINTAINCE.

2. Press the rotary to enter the coffee machine maintenance menu, jog shuttle dial to " rinse milk unit " page.

3. Press the rinse button to confirm wash into " rinse milk unit " .

4. Follow the screen prompts to put the milk tube into the hole , press the button to start cleaning the milk unit.

5. After cleaning, coffee machine enter the Ready state.

5.2.4 Wipe the coffee machine

Power off and pull out plug before clean the inside machine.
 Do not put the machine in the water to avoid electric shock
 Do not use metal object to clean the machine.
 Do not clean any components by dish-washing machine.



1. Clean drip tray



Dry the 2 terminals and the end of the drip tray.



2. Clean water tank
 Clean water tank by flowing water.

Function test and maintenance methods



3. Clean coffee bean container and the hopper
Use dry rag or tissue clean rest oil inside bean container. Do not use water to wash bean container.



4. Clean hopper
Use dry rag clean the channel of hopper. Do not use water to wash hopper channel.

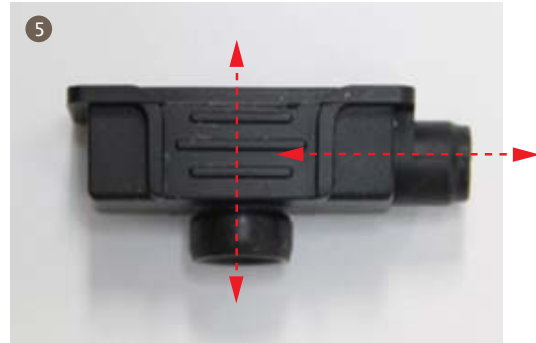
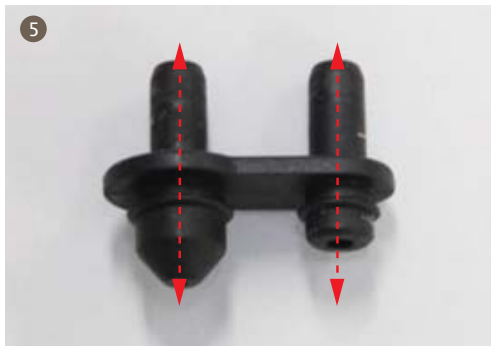

5. Clear foam rubber
Clear all the holes of the foam rubber and clean them by water.



Clean all the parts by water



6. Clean the internal machine
Clean base

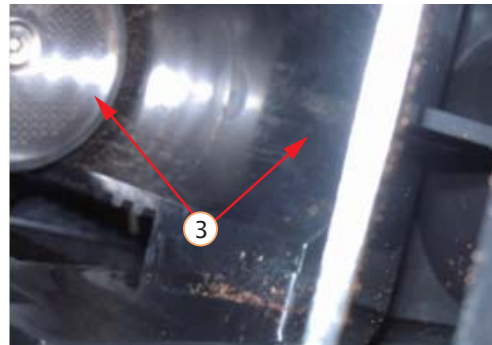
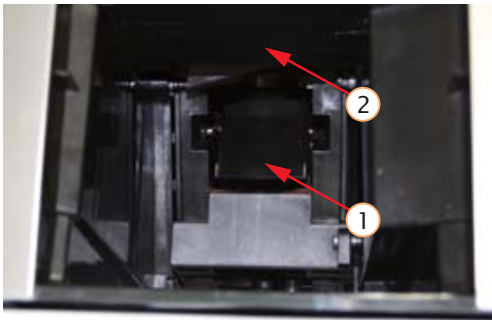

Clean brew unit-coffee brewing box(position 1) and contropistone(position 3 and position 2 is the back side)



7. Clean coffee machine.
Use dry and soft rag to clean the appearance of the coffee machine.

6. Explosive view

Dispenser valve 6W
8810101001

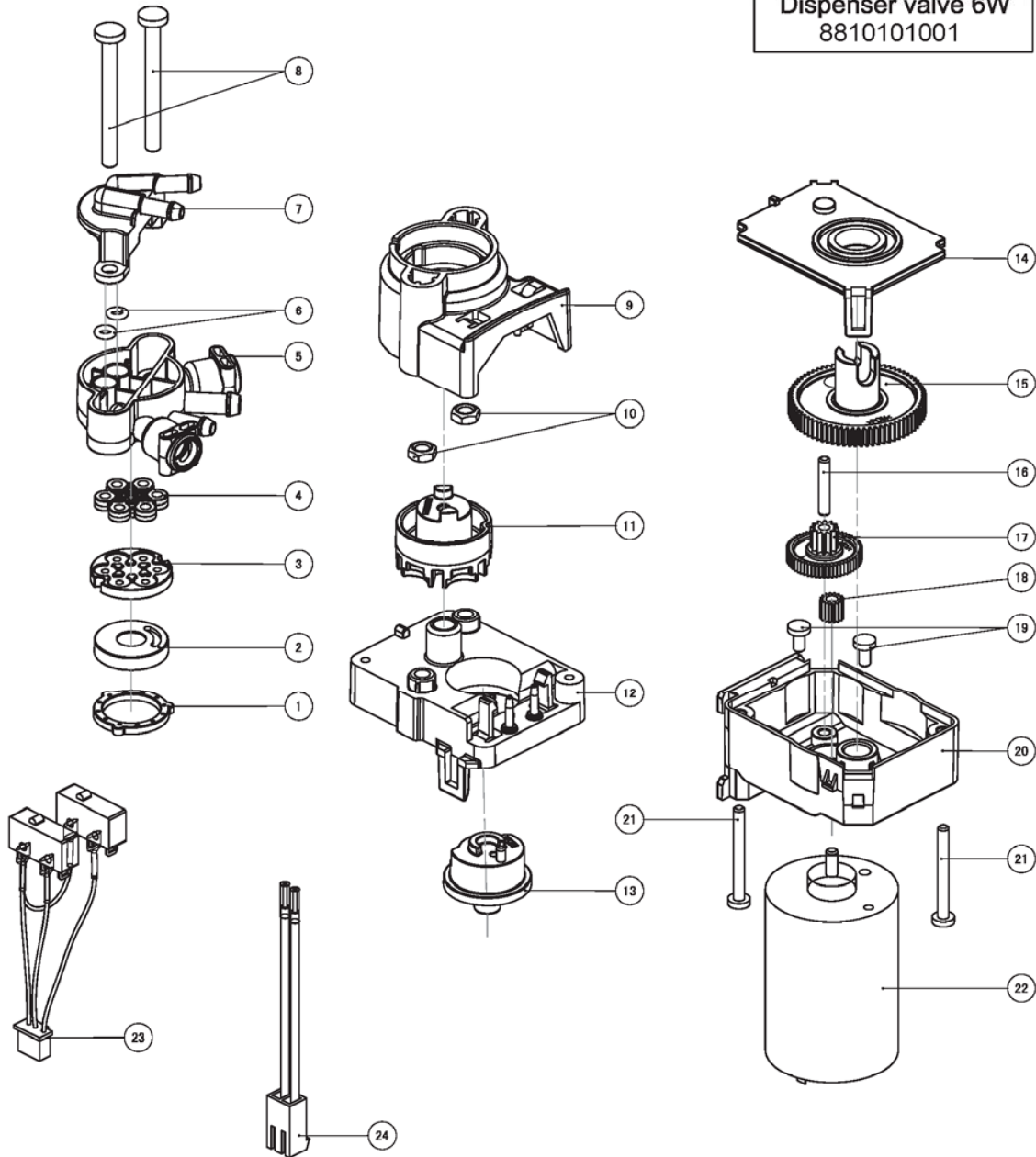

POS	CODE	DESCRIPTION	NOTE
1	73000001	Ceramic plate A	
2	73000002	Ceramic plate B	
3	73000003	Ceramic plate C	
4	73000007	Ceramic plate sheet gasket	Silicone
5	79000009	Water distributor	
6	73000008	O-ring Ø3.0×Ø6.0	
7	79000010	Water distributor lid	
8	72000014	Screw M4.0×40	
9	79000008	Ceramic plate support	
10	72000017	Hex nut	
11	79000007	Sheave	
12	79000002	Sheave permanent seat	
13	79000006	Sheave drive part	

POS	CODE	DESCRIPTION	NOTE
14	79000005	Gear box lid	
15	79000003	Dispenser valve gear B	
16	73000005	Gear pin	
17	79000004	Dispenser valve gear A	
18	73000004	Dispenser valve gear	Cuprum
19	72000009	Screw M3.0×6	
20	79000001	Screw ST3.0×28	
21	72000032	Gear box for dispenser valve	
22	73000010	Motor for dispenser valve	DC24V
23	78000008	Microswitch line pencil	
24	78000009	Line pencil	

Explosive view

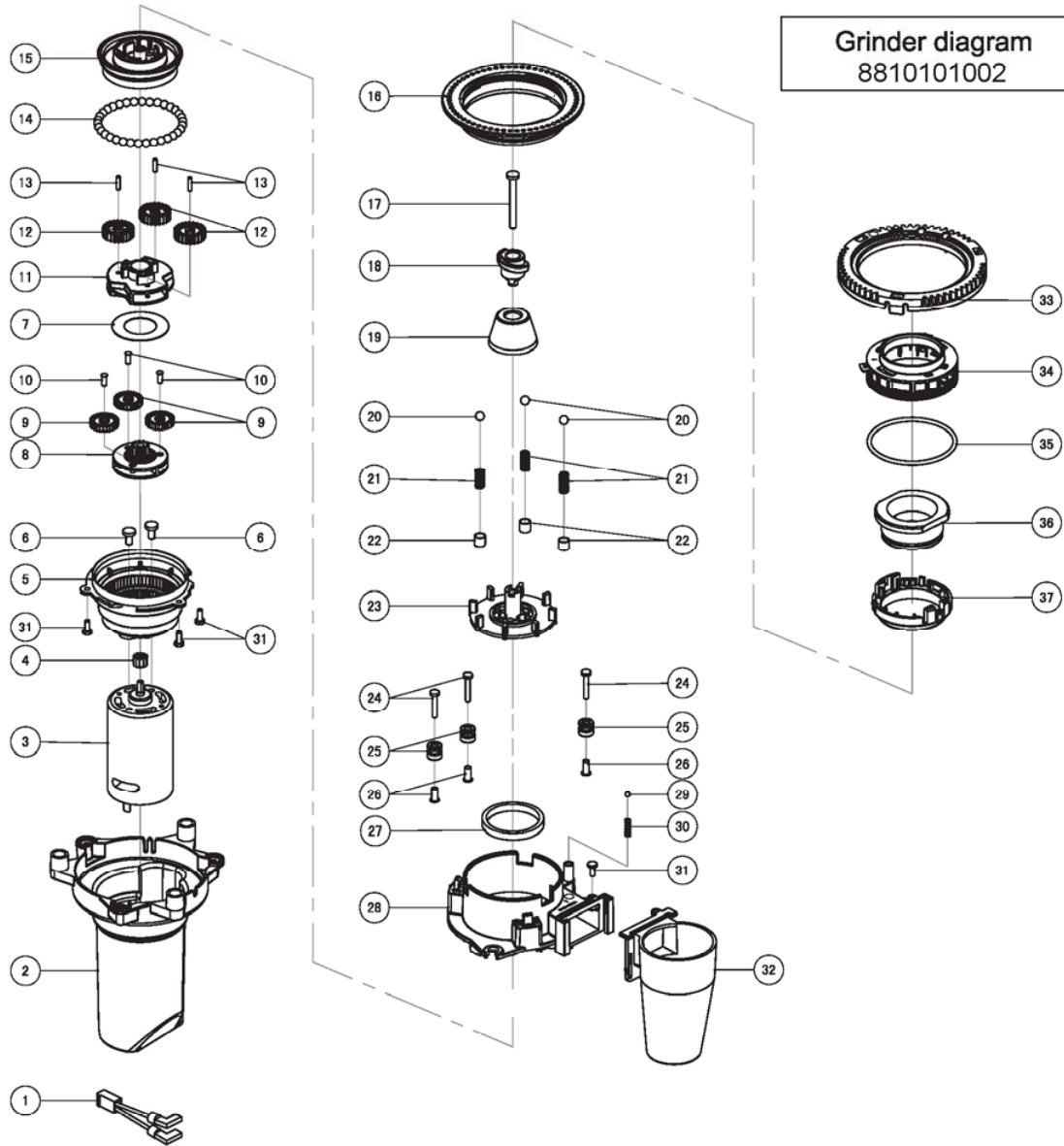

POS	CODE	DESCRIPTION	NOTE
1	78000020	Line pencil	
2	79000011	Grinder support	
3	73000024	Grinder motor	DC220V
4	73000020	Grinder gear	
5	79000014	Grinder gear box	
6	72000011	Screw M4.0×8	
7	78000167	Filler piece	
8	79000021	Epicyclic gear support A	
9	79000022	Epicyclic gear A	
10	73000016	Epicyclic gear pin A	
11	79000023	Epicyclic gear support B	
12	79000025	Epicyclic gear B	
13	73000017	Epicyclic gear pin B	
14	73000027	Steel ball Ø5.0	
15	79000024	Steel ball support	
16	79000016	Grinder adjustment ring	
17	72000021	Screw ST4.0×38	
18	79000020	Screw pin worm drive	
19	73000023	Conical burr	
20	73000026	Steel ball Ø5.5	

POS	CODE	DESCRIPTION	NOTE
21	73000014	Spring Ø5.8×13.0	
22	73000018	Spring sleeve	
23	79000019	Support lower grinder	
24	72000008	Screw ST3.0×18	
25	73000012	Antivibration for grinder	NBR
26	73000019	Anticibration bush	
27	73000021	Felt ring	
28	79000015	Motor support for grinder	
29	73000025	Steel ball Ø3.0	
30	73000015	Spring Ø3.5×12.0	
31	72000002	Screw ST3.0×8	
32	79000012	Coffee powder hopper	
33	79000013	Grinder adjustment sector	
34	79000017	Upper grinder support	
35	73000013	O-ring Ø53.0×Ø58.0	Silicone
36	73000022	Upper burr	
37	79000018	Upper grinder cover	

Drainage Valve 8810101006

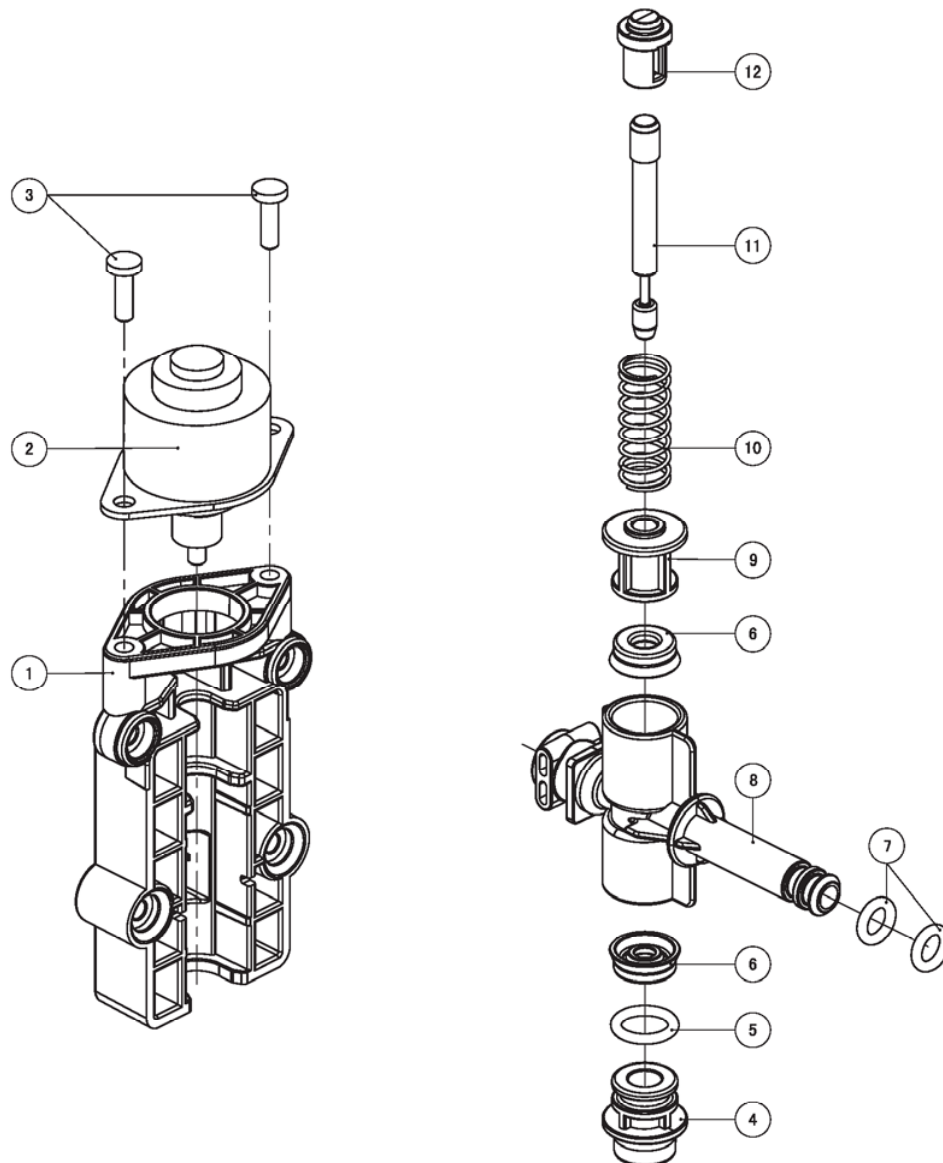

POS	CODE	DESCRIPTION	NOTE
1	79000038	Drain valve support	
2	73000040	Stepper motor	DC24V
3	72000004	Screw ST3.0×12	
4	79000035	Drainage export	
5	73000036	O-ring Ø8.0×Ø11.6	Silicone
6	73000037	Y-ring Ø3.6×Ø12.01	
7	73000035	O-ring Ø5.0×Ø8.6	
8	79000034	Drainage valve connection	Silicone
9	79000036	Pin sleeve	Silicone
10	73000038	Spring Ø8.8×22.5	FKM

POS	CODE	DESCRIPTION	NOTE
11	73000039	Pin	
12	79000037	Pin cover	

Control panel group
8810101007

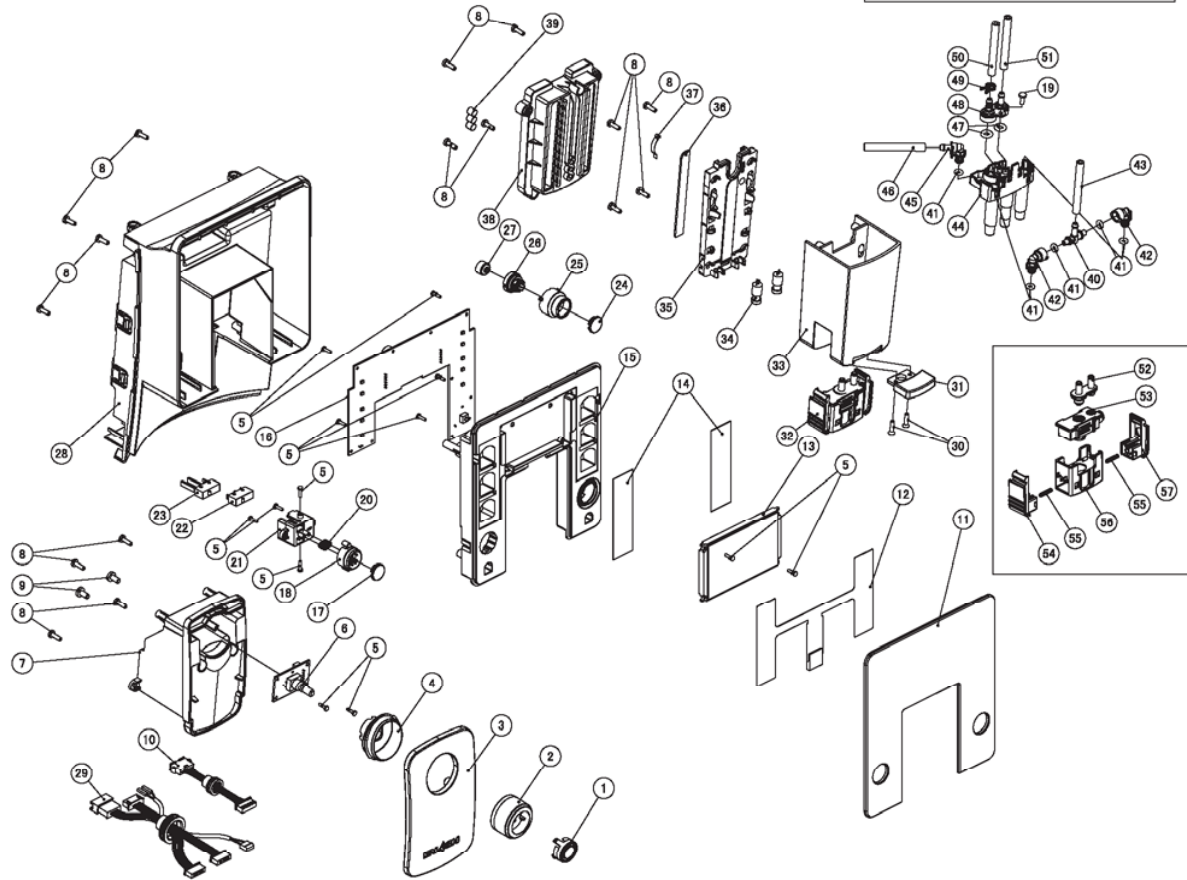

POS	CODE	DESCRIPTION	NOTE
1	79000059	Rotary decorative cover	
2	79000058	Rotary	
3	79000065	Decorative plate	
4	79000041	Rotary smokebell	
5	72000001	Screw ST2.0×8	
6	78000003	Rotary pcb	
7	79000042	Touch screen decorative cover	
8	72000004	Screw ST3.0×10	
9	72000011	Screw M4.0×8	
10	78000013	Line pencil	
11	73000049	Touch screen	Glass
12	78000004	ITO	
13	78000086	Display screen	
14	73000127	NC film	
15	79000044	PCB support	
16	78000002	Touch screen PCB	
17	79000171	Power button decorative cover	
18	79000063	Power button	
19	72000002	Screw ST3.0×8	
20	73000042	Spring Ø4.6×6.5	
21	79000062	Power microswitch support	
22	78000025	Line pencil	
23	73000051	Microswitch	
24	79000060	Clean button decorative cover	
25	79000061	Clean button smokebell	
26	79000064	Clean button	
27	73000047	Clean button filler piece	Silicone
28	79000039	Support elect	
29	78000024	Line pencil	

POS	CODE	DESCRIPTION	NOTE
30	72000003	Screw ST3.0×12	SUS
31	79000066	Handle	
32	8810101022	Foam group	
33	79000045	Coffee exprot base	
34	78000023	LED	
35	79000051	Coffee export sliding panel	
36	79000067	Magnet sliding panel	
37	79000068	Shell fragment	
38	79000043	Coffee exprot support	
39	73000052	Magnet	
40	79000049	Coffee diverter pipe	
41	73000029	O-ring Ø3.3×Ø7.3	Silicone
42	79000048	coffee connector	
43	73000116	Silicon pipe Ø3.0×Ø6.0 215mm	Silicone
44	79000046	Coffee export	
45	79000052	Hot water connector	
46	73000117	Silicon pipe Ø3.0×Ø6.0 380mm	Silicone
47	73000044	O-ring Ø5.0×Ø10.0	Silicone
48	79000047	Steam connector	
49	73000043	Tube clip	
50	73000121	Strengthen pipe Ø3.0×Ø6.0 340mm	Silicone
51	73000119	Silicon pipe Ø3.0×Ø6.0 270mm	Silicone
52	79000056	Steam tube	
53	79000187	Foam rubber	
54	79000054	Button A	
55	73000041	Spring Ø2.8×16.4	
56	79000053	Foam export	
57	79000055	Button B	

Brew unit
8810101016

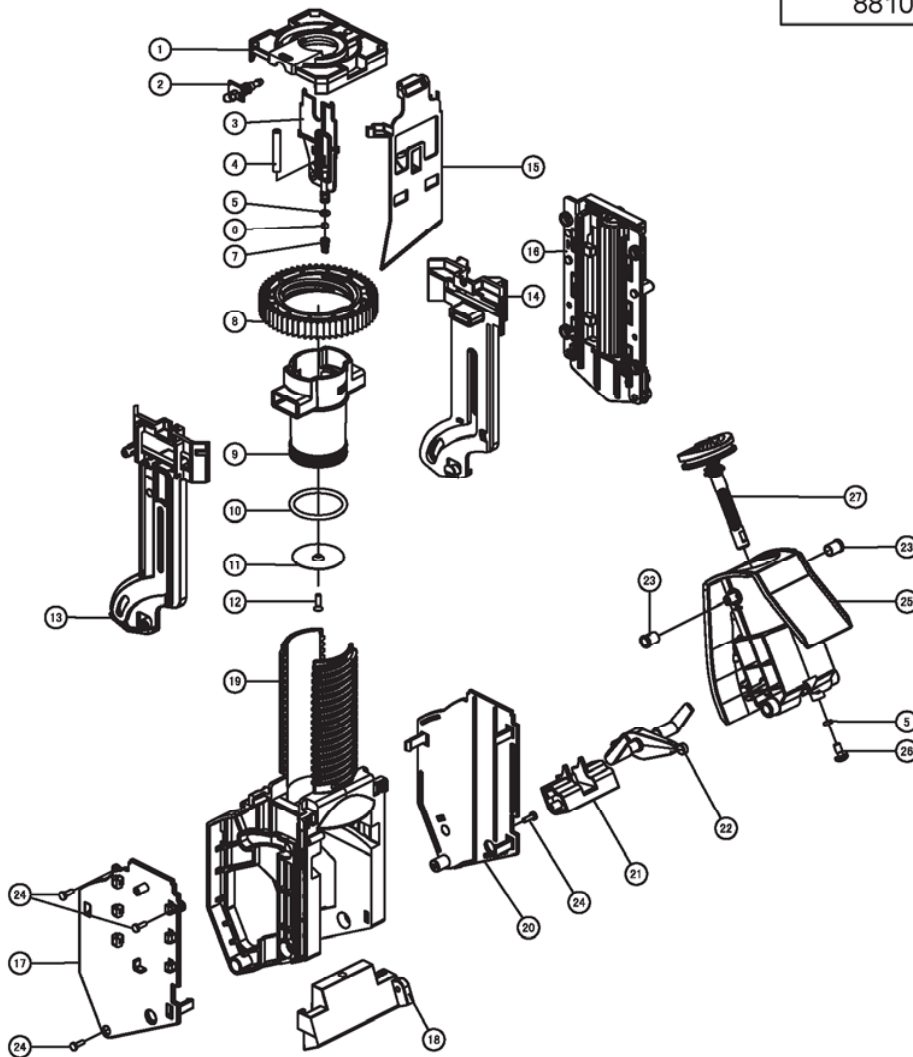

POS	CODE	DESCRIPTION	NOTE
1	7900088	Brew unit cover	
2	79000185	Coffee faucet	
3	79000184	Contacter	
4	73000116	Silicon pipe $\varnothing 3.0 \times \varnothing 6.0$ 85mm	Silicone
5	73000029	O-ring $\varnothing 3.3 \times \varnothing 7.3$	Silicone
6	73000148	Ball $\varnothing 5.0$	
7	73000073	Screw $\varnothing 6.8 \times 10.5$	
8	79000091	Brew unit gear	
9	79000101	Contropistone	
10	73000065	O-ring $\varnothing 37.69 \times \varnothing 44.75$	Silicone
11	73000088	Filter screen	
12	72000025	Screw ST3.5 $\times 12$	SUS
13	79000086	Left pull plate	
14	79000085	Right pull plate	
15	79000092	Wiper	
16	8810101015	Spool gear group	
17	79000089	Brew unit left cover	
18	79000096	Connect part	

POS	CODE	DESCRIPTION	NOTE
19	79000084	Brew unit support	
20	79000090	Brew unit right cover	
21	79000094	Reset base	
22	79000087	Release link	
23	73000067	Sleeve pipe	
24	72000004	Screw ST3.0 $\times 10$	
25	8810101023	Coffee brewing Group	
26	72000027	Screw ST5.0 $\times 8$	SUS
27	8810101024	Piston group	

Bean container transparent
8810101019

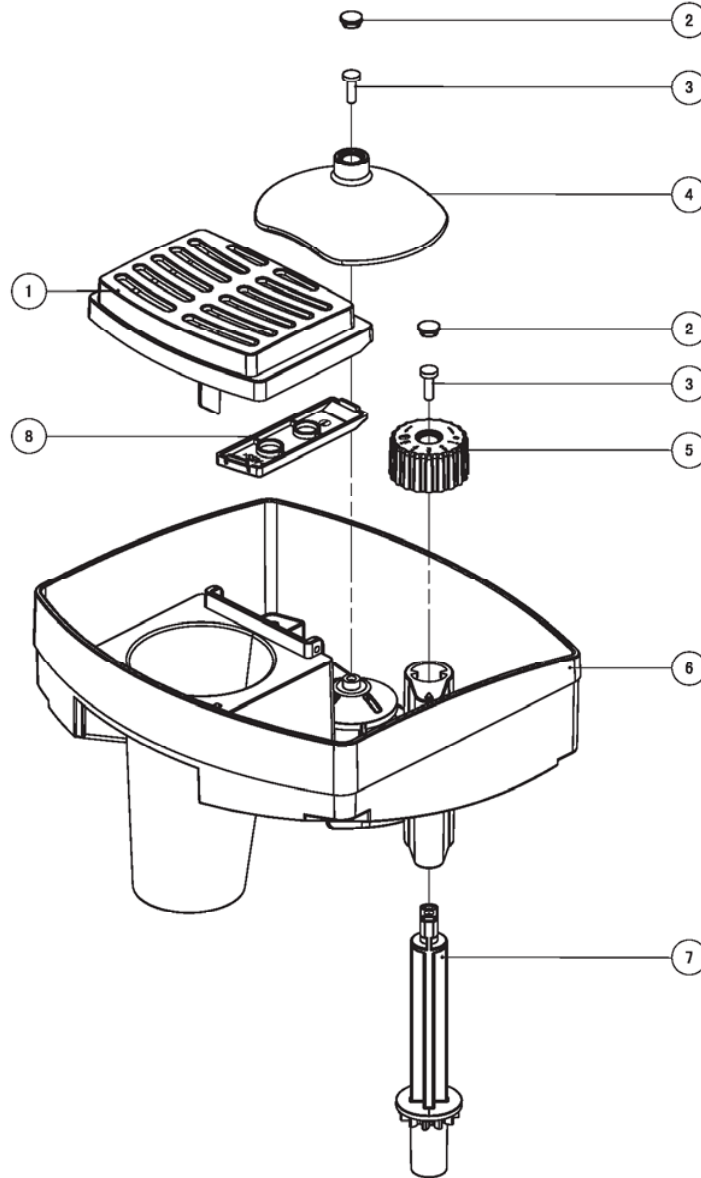

POS	CODE	DESCRIPTION	NOTE
1	79000123	Ground coffee container lid	
2	79000040	Screw cover	
3	72000004	Screw ST3.0×12	
4	79000120	Finger guard	

POS	CODE	DESCRIPTION	NOTE
5	79000125	Grinder adjustment grey knob	
6	79000119	Bean container transparent	
7	79000124	Connection axle	
8	79000200	Warning cover	

Water tank group
8810102005

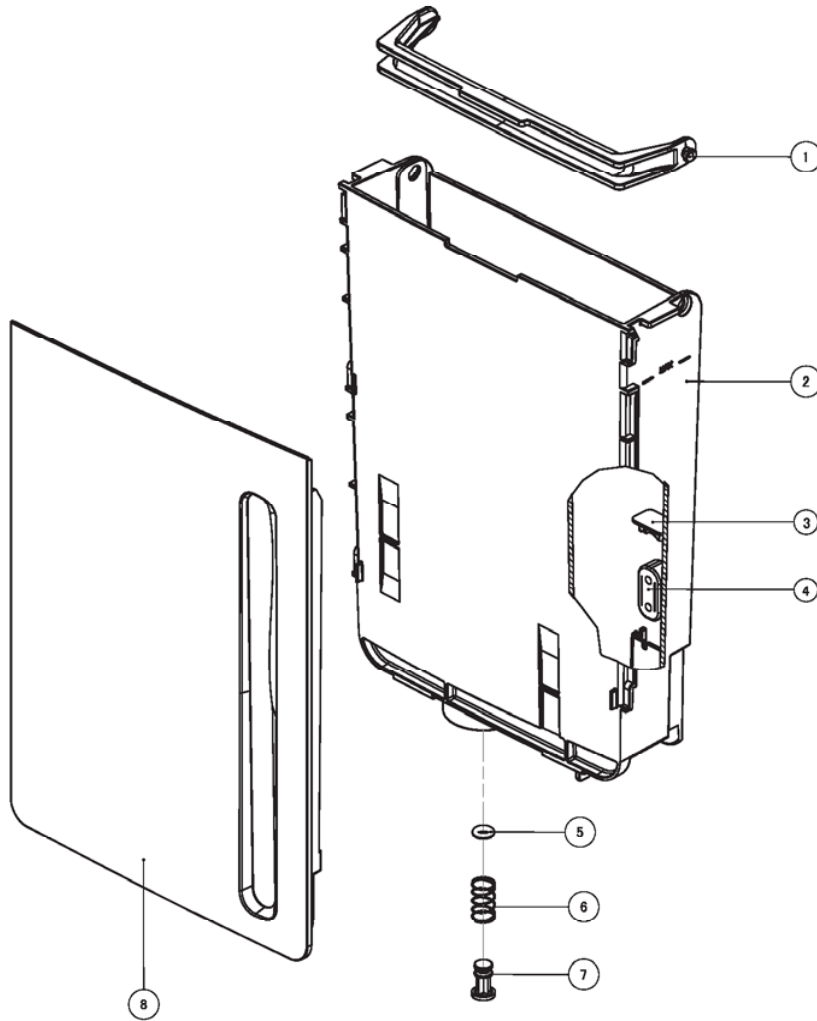

POS	CODE	DESCRIPTION	NOTE
1	79000135	Water tank handle	
2	79000133	Water tank	
3	79000136	Float cover	
4	73000081	Magnet	

POS	CODE	DESCRIPTION	NOTE
5	73000077	O-ring Ø5.0×Ø11.0	Silicone
6	73000078	Spring Ø11.6×20	
7	79000137	Valve body	
8	79000134	Water tank ornament cover	

Explosive view

Thermobloc group
8810101025

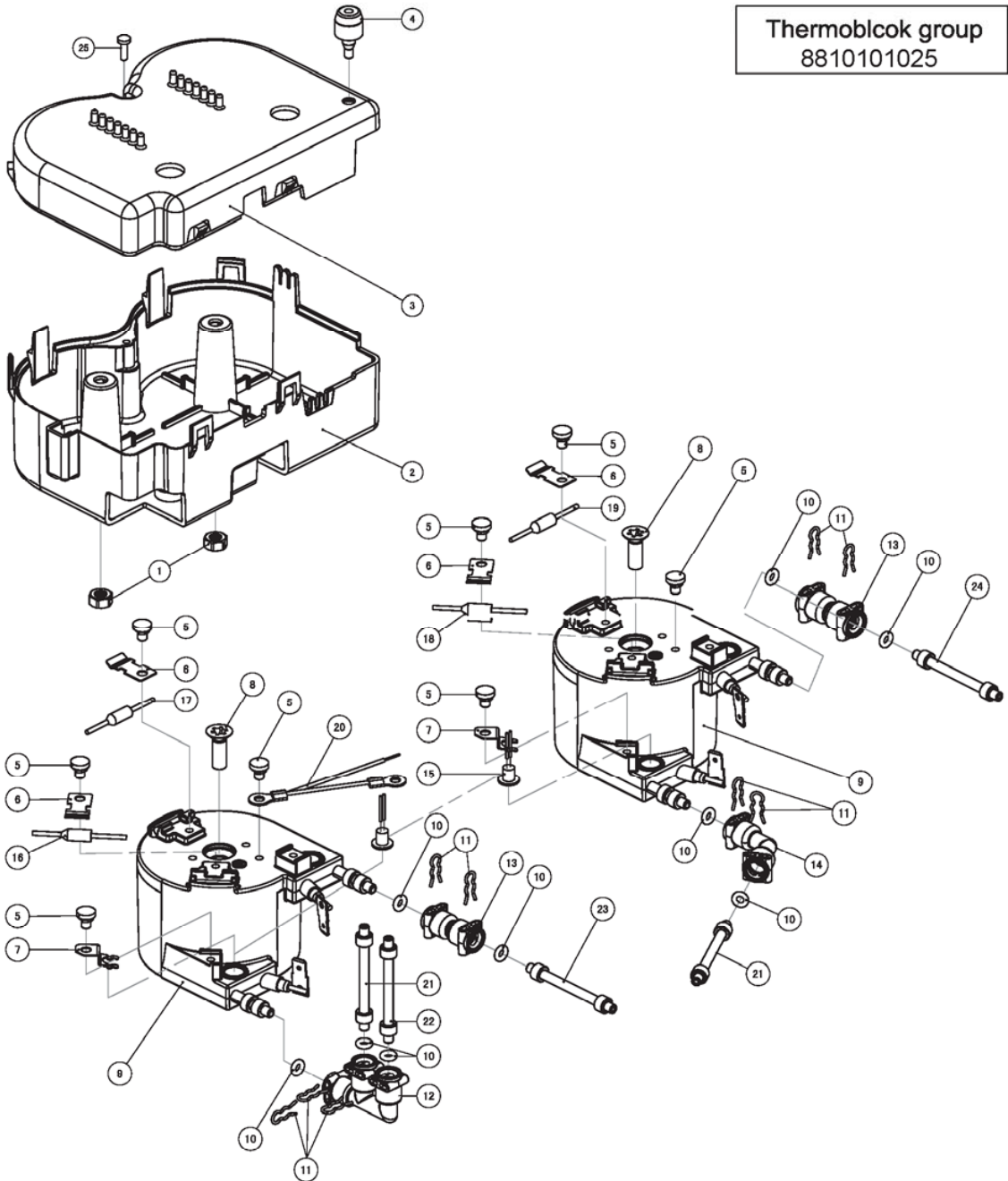

POS	CODE	DESCRIPTION	NOTE
1	72000018	Hex Nut M6.0	
2	79000126	Thermoblock box	
3	79000151	Thermoblock cover	
4	73000129	Thermoblock cover support	NBR
5	72000023	Screw M4.0×6	
6	79000130	Fuse clamp	
7	79000131	Sensor clamp	
8	72000015	Screw M6.0×14	
9	79000132	Thermoblock	220V/1200W
10	73000029	O-ring Ø3.3×Ø7.3	Silicone
11	73000066	Clamp	
12	79000128	Connection F	
13	79000127	Connection I	

POS	CODE	DESCRIPTION	NOTE
14	79000129	Connection L	
15	73000074	Sensor thermoblock complete	
16	78000014	Coffee fused-cord	216°C
17	78000015	Coffee fused-cord	216°C
18	78000016	Steam fused-cord	216°C
19	78000017	Steam fused-cord	216°C
20	78000018	Ground wire 205mm	
21	73000142	Telfon pipe 178mm	
22	73000143	Telfon pipe 103mm	
23	73000141	Telfon pipe 65mm	
24	73000140	Telfon pipe	
25	72000004	Screw ST3.0×10	

9810101001-1

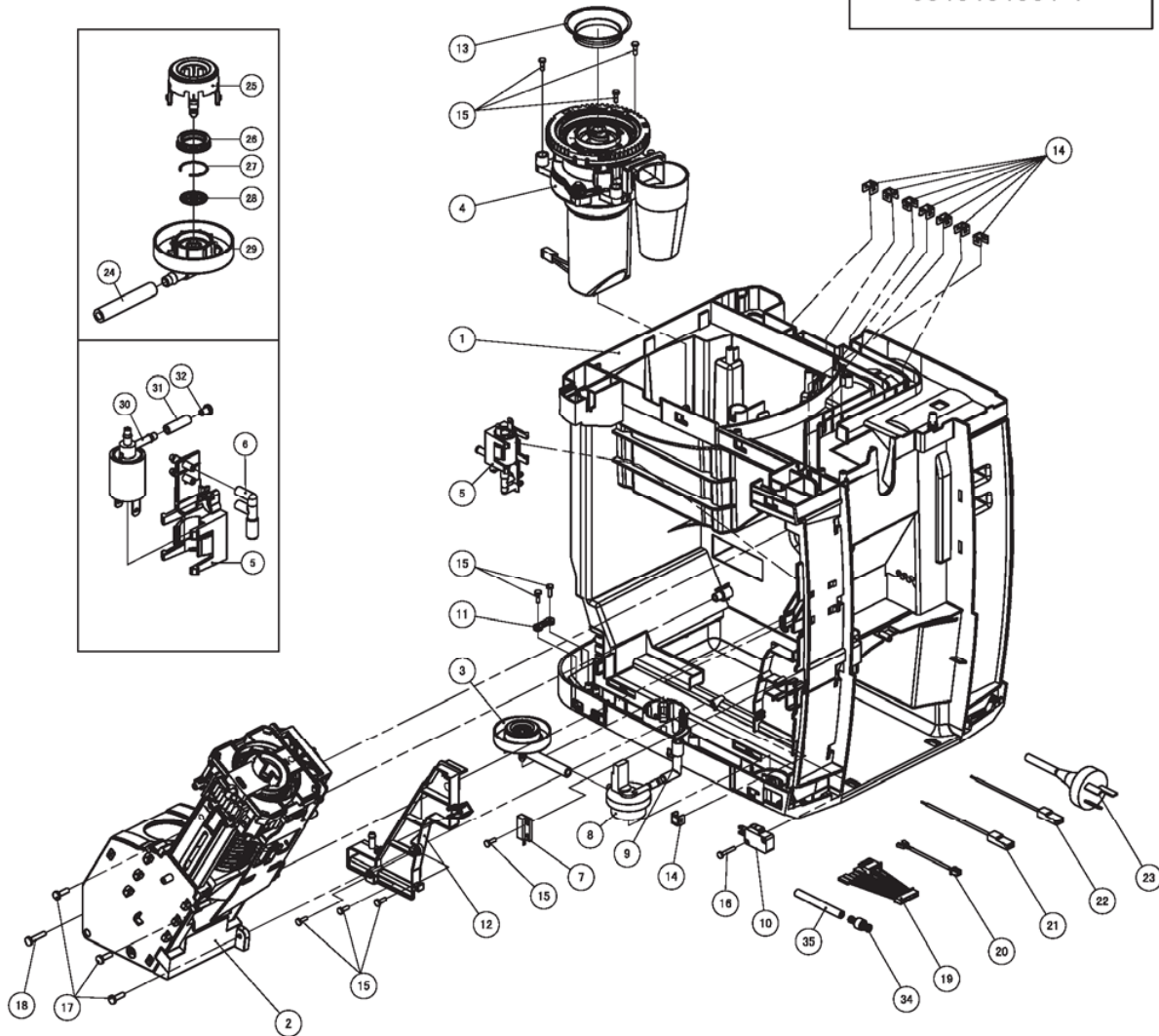

POS	CODE	DESCRIPTION	NOTE
1	8810101021	Frame	
2	8810101016	Brew unit group	
3	8810101005	Water inlet valve	
4	8810101002	Grinder group	
5	8810101012	Solenoid valve group	
6	73000058	Connection F	
7	73000095	Reed sensor	
8	73000089	Flowmeter	
9	73000084	Angled flange black	
10	73000088	Microswitch	
11	79000155	Power cord retaining clip	
12	79000156	Frame support	
13	73000096	Bean coffee container seal	
14	79000163	Clamp	
15	72000004	Screw ST3.0×10	
16	72000008	Screw ST3.0×18	
17	72000012	Screw M4.0×14	
18	72000013	Screw M4.0×20	
19	78000022	Line pencil	
20	78000021	Line pencil	

POS	CODE	DESCRIPTION	NOTE
21	78000027	Line pencil	
22	78000026	Line pencil	
23	78000007	Power cord	
24	73000111	Waterpipe Ø5.0×Ø9.0 120mm	Silicone
25	79000033	Valve cap	
26	73000033	Y-ring Ø14.9×Ø22.1	Silicone
27	73000032	Safetyring	
28	79000166	Sieve	
29	79000032	Valve support	
30	73000057	Solenoid valve	DC24V
31	73000120	Silicon tube	
32	79000188	Inlet port	
33	79000072	Solenoid valve support	
34	79000057	Milk connector tube	
35	78000019	Silicon tube Ø3.0×Ø6.0 330mm	

9810101001-2

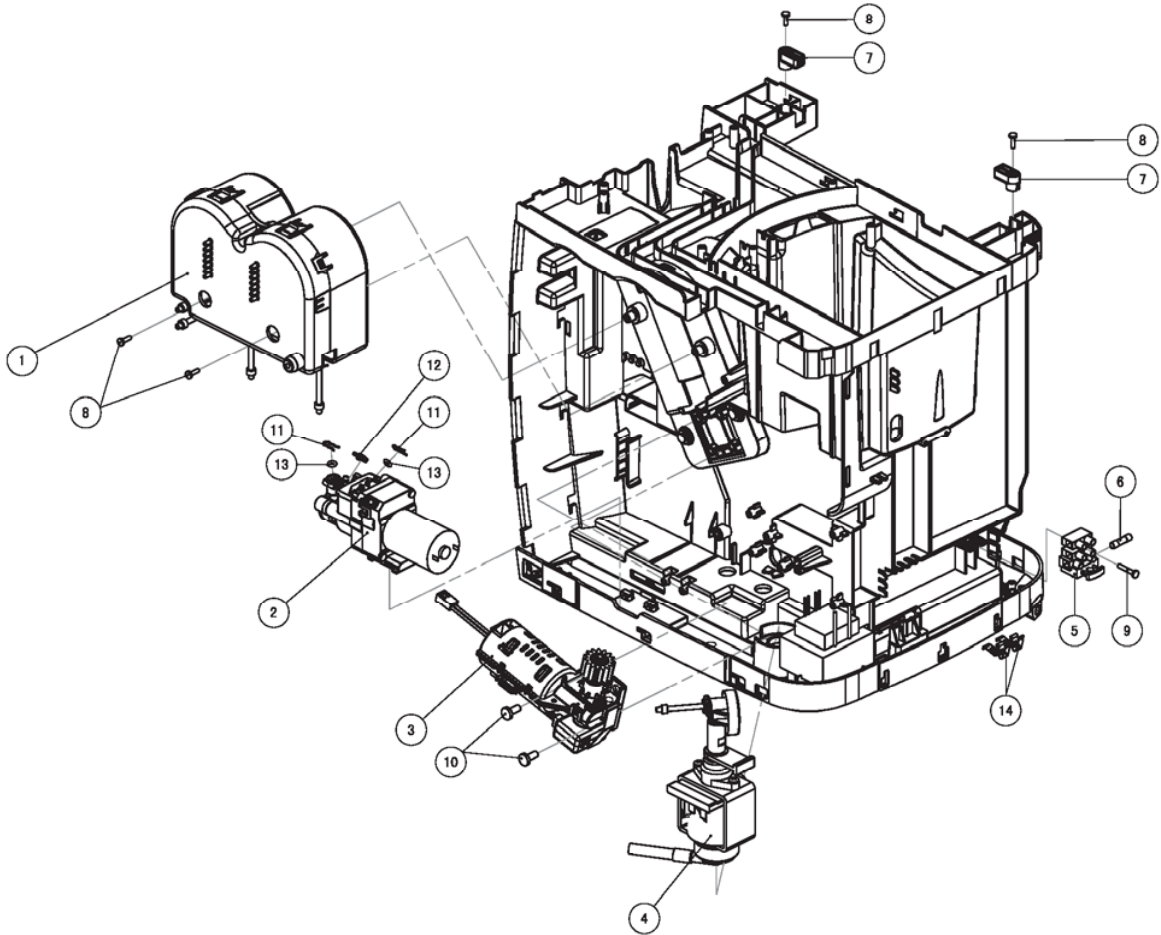

POS	CODE	DESCRIPTION	NOTE
1	8810101025	Thermoblock group	220V/1200W
2	8810101006	Dispenser Valve 6W Group	DC24V
3	8810101014	Geared motor group	DC24V
4	8810101011	Pump group	
5	73000029	Line pencil connector	
6	73000086	Fuse	10A
7	79000035	Screw support	
8	73000036	Screw ST3.0×10	
9	73000037	Screw ST3.0×18	
10	73000035	Screw M5.0×12	

POS	CODE	DESCRIPTION	NOTE
11	73000086	Clamp	
12	73000043	Tube clip	
13	73000029	O-ring Ø3.3×Ø7.3	Silicone
14	79000160	Terminal	

9810101001-3

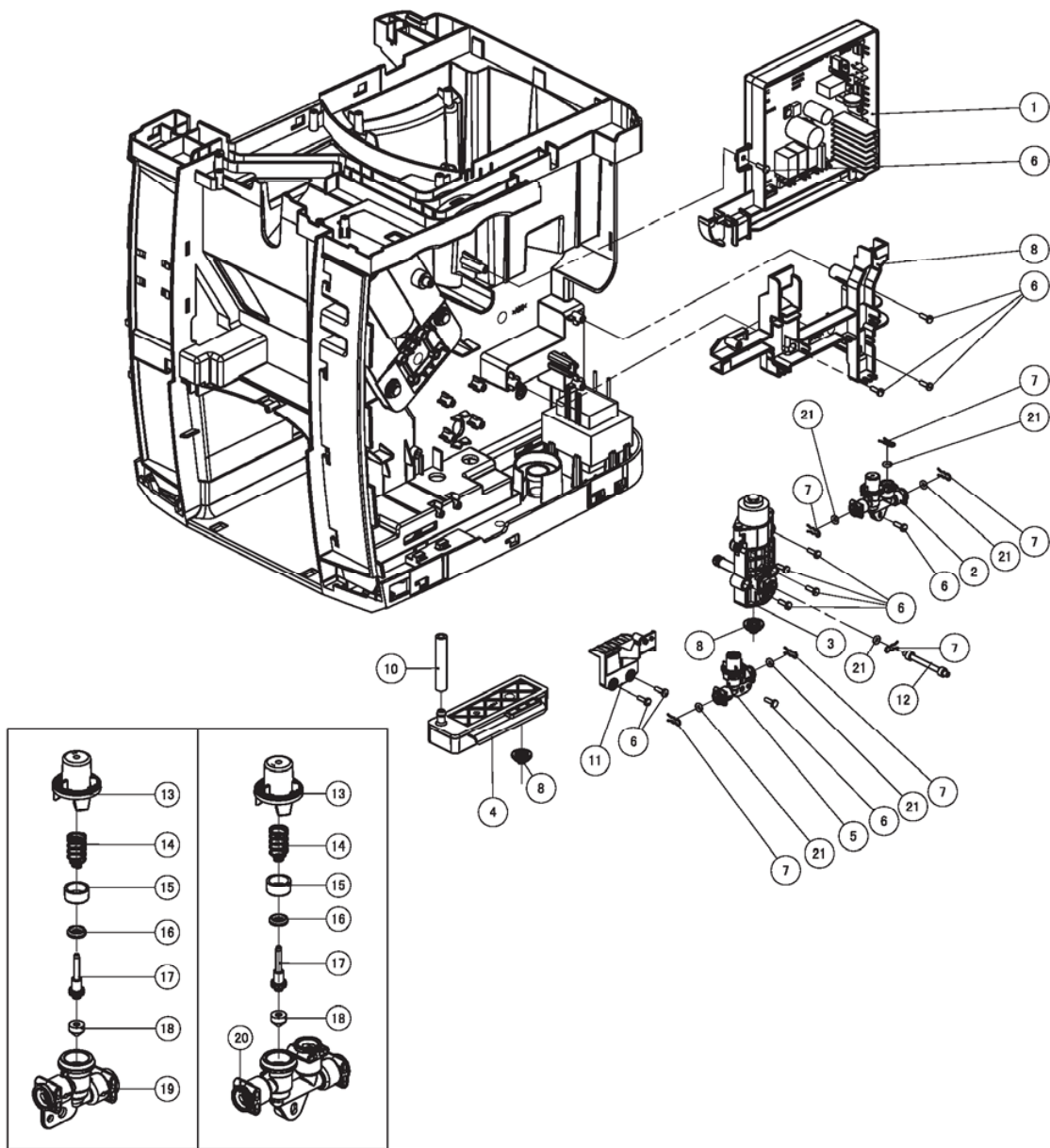

POS	CODE	DESCRIPTION	NOTE
1	8810101018	Power PCB group	
2	8810101003	Dispenser valve 3W	
3	8810101006	Drainage Valve	
4	8810101049	Condensator	
5	8810101004	Dispenser valve 2W	
6	72000004	Screw ST3.0×10	
7	73000066	Clamp	
8	73000092	Drainage seal ring	Silicone
9	79000154	Line pencil frame	
10	73000114	Silicon pipe Ø5.0×Ø9.0 125mm	Silicone
11	79000030	Dispenser valve support	

POS	CODE	DESCRIPTION	NOTE
12	73000146	Teflon pipe G-110mm	
13	79000027	Dispenser valve cover	
14	73000030	Spring Ø7.7×21.0	
15	79000029	Spring support	
16	73000128	O-ring Ø4.0×Ø7.6	Silicone
17	79000028	Valve pin	
18	73000028	Seal cap	Silicone
19	79000031	Valve body 2W	
20	79000026	Valve body 3W	
21	73000029	O-ring Ø3.3×Ø7.3	Silicone

9810101001-4

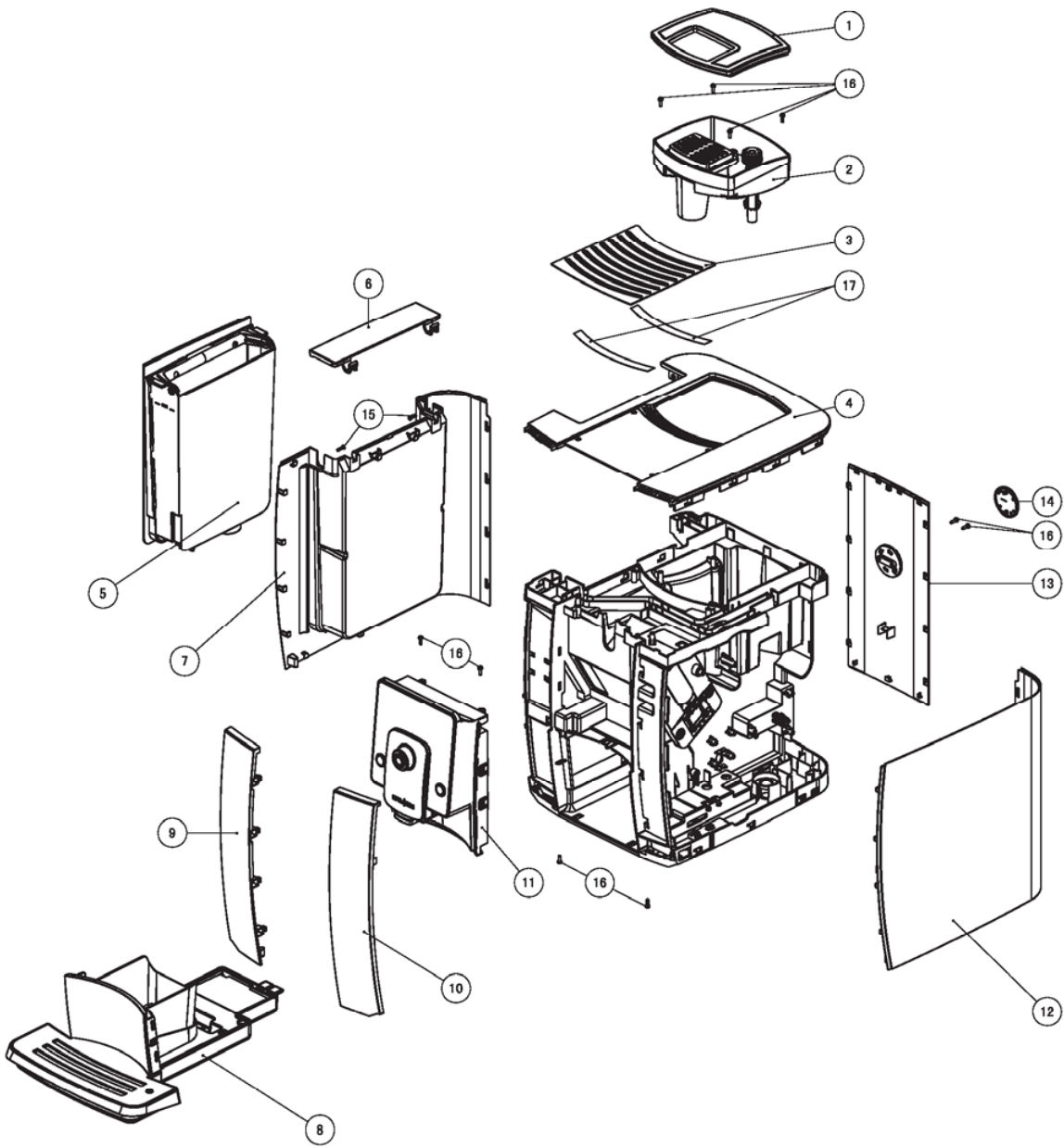

POS	CODE	DESCRIPTION	NOTE
1	881010025	Bean container lid	
2	8810101019	Bean container transparent	
3	79000181	Cup support	
4	79000152	Top cover	
5	8810102005	Water tank group	
6	79000153	Water tank cover	
7	79000148	Left side section	
8	8810101017	Pan group	
9	79000146	Front cover left	
10	79000147	Front cover right	

POS	CODE	DESCRIPTION	NOTE
11	8810101007	Control panel group	
12	79000149	Right side section	
13	79000145	Back cover	
14	881010027	Logo support	
15	72000003	Screw ST3.0×12	SUS
16	72000004	Screw ST3.0×10	
17	73000176	Foam tape	



Suzhou Industrial Park Kalem Electric Appliances Co., Ltd

www.kalerm.com

+86-4006-800-866

Add: #100 Sumu Rd, SIP Suzhou, 215021, Jiangsu China

Te l: +86-512-68180758

Fax: +86-512-68181050